

**Copeland Scroll™**

# Efficient Comfort Solutions

For Residential And Commercial Applications





## Heat Pumps - An Efficient Technology Using Renewable Energy

Environmental impact, reduction of carbon footprint and energy consumption are at the centre of every discussion. New legislation such as the Energy Performance of Buildings (EPBD) directive, the Renewable Energy Sources (RES) directive and the Ecodesign have been implemented to improve the use of primary energy and promote energy efficiency in heating and cooling applications.

Although the RES directive acknowledges air, water and ground as renewable energy sources, most water heaters on the market today still use fossil fuels or direct electricity.

Heat pumps are recognized as the technology of choice to make renewable energy usable.

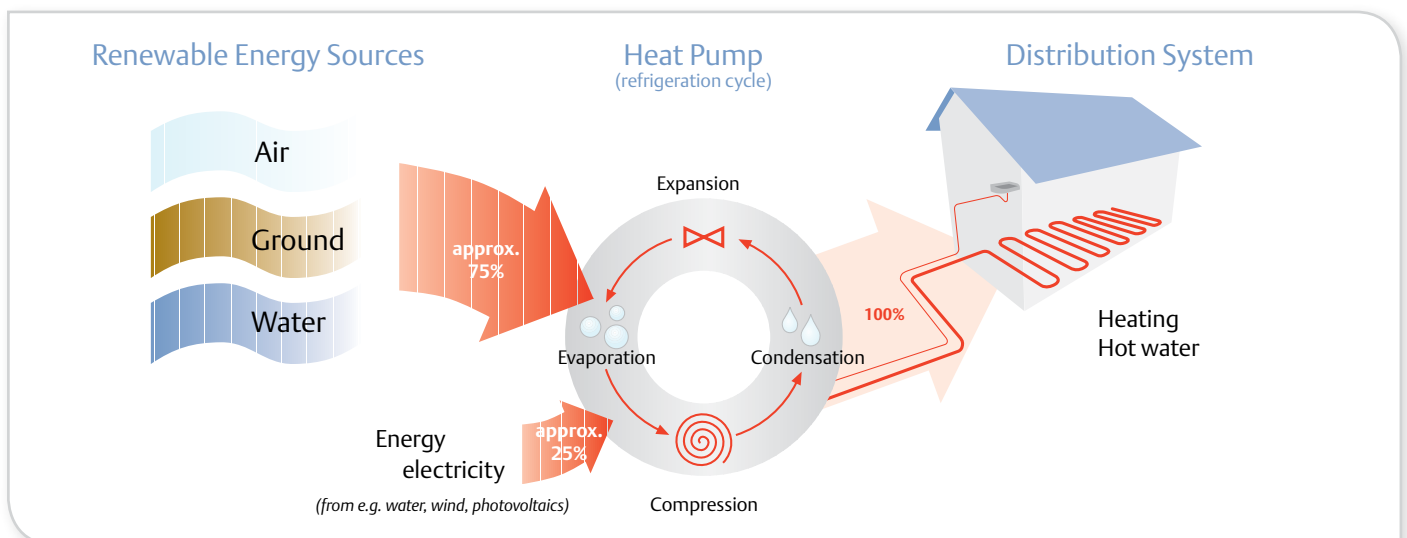

The working principle of heat pump technology

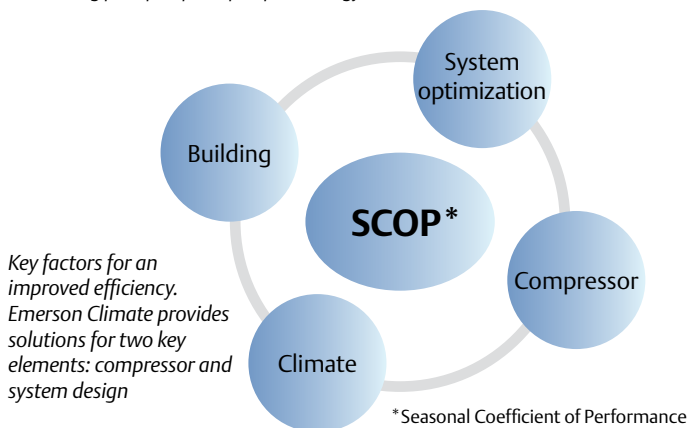

### Key Factors For An Improved Efficiency

Several elements impact the seasonal performance (SCOP) of heat pump systems. **Building** insulation and **climate** play a major role by influencing the heat pump peak load and the required water temperatures. These elements tend to increase the complexity of the heat pump system design for manufacturers, because they require different system optimizations and configurations.

Emerson Climate Technologies focuses on improving seasonal performance by providing **compressors** and **system optimization** solutions which improve the overall efficiency and reliability of heat pumps while reducing their complexity.

## Providing Efficient And Reliable Solutions For Comfort Applications

Emerson Climate Technologies offers a complete range of solutions for dedicated heating and reversible system applications. The new range of R410A optimized compressors, along with our selection of electronic expansion valves and controllers guarantee reliable, efficient and fast to market solutions for all major applications in the commercial and residential air conditioning and heat pump market.



EFFICIENCY



RELIABILITY



LOW LIFE CYCLE COST

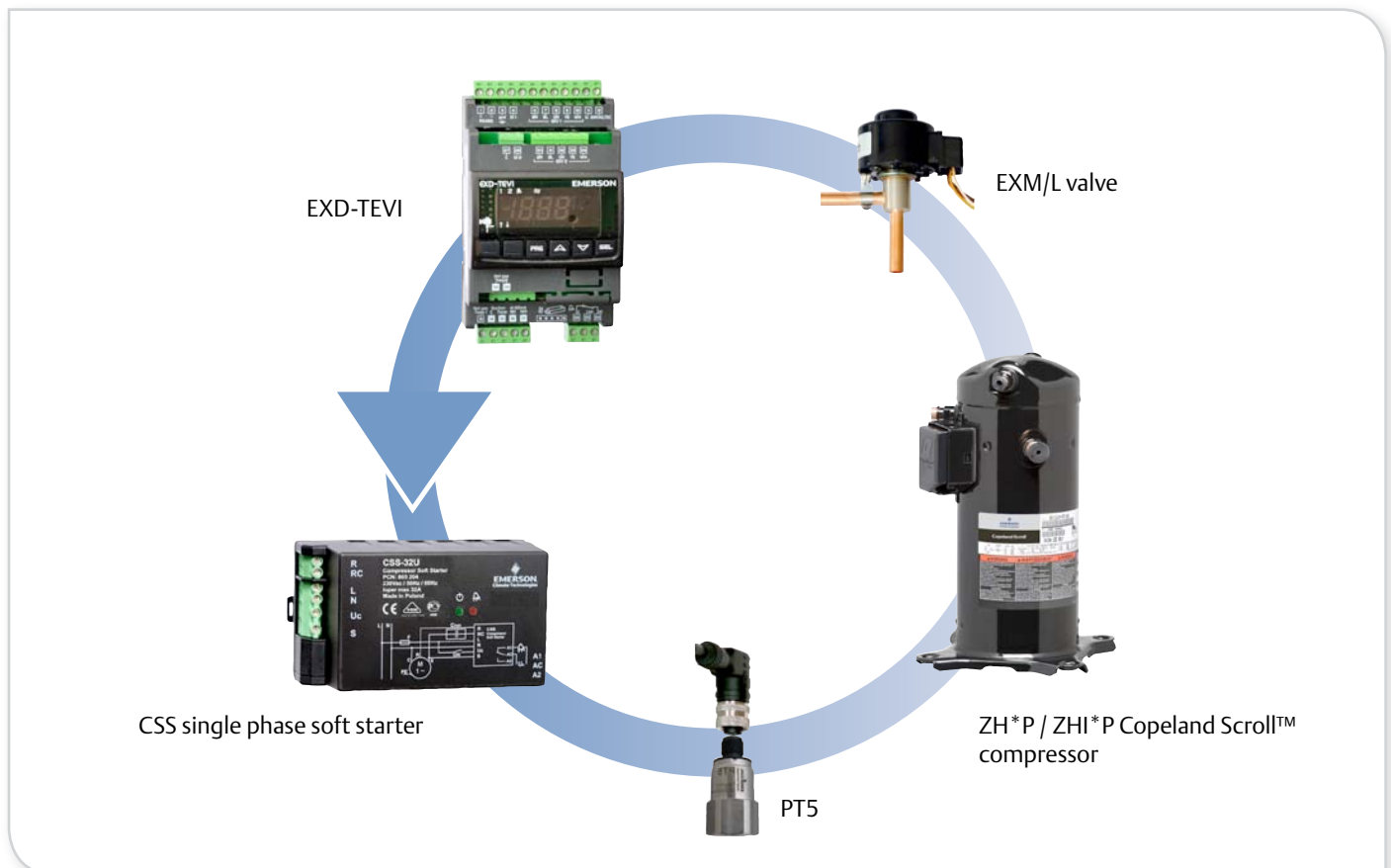

## Combining State-Of-The-Art Technologies To Maximize Heat Pump Performance

Emerson Climate Technologies' state-of-the-art offering is based on:

- **ZH\*P** R410A scroll compressors for comfort applications in warmer and average climates
- **ZHI\*P** R410A scroll compressors with Enhanced Vapor Injection for average and colder climates
- **EXD-HP1/2** system and economizer superheat controller for residential applications
- **EXD-TEVI** economizer superheat controller for commercial applications
- **EXM/L** electronic expansion valve family suitable for wide envelope operations
- **CSS** single phase soft starter, the only VDE certified soft starter on the market
- **PT5** high accuracy pressure sensor

# ZH\*P Scroll Compressors

## Comfort In Average & Warm Climates

### Application

The new R410A Copeland heating scroll technology enables system manufacturers to develop highly efficient and reliable heat pumps as well as reversible systems - for various climates and in various configurations.

ZH\*P scrolls are suitable for brine to water and air to water heat pumps, dedicated and reversible, for the average and warm European climates. They feature a wider operating envelope compared to traditional air conditioning scroll compressors and cover medium water temperature applications (45-55°C) in warm and average climates.



### Features and Benefits

- Full range of R410A compressors with up to 40 kW heating capacity
- Full range of Copeland qualified tandems with up to 80kW heating capacity per circuit
- Superior seasonal performance in heating (SCOP) and cooling (SEER)
- Low sound and vibration level

### ZH\*P (R410A) Envelope

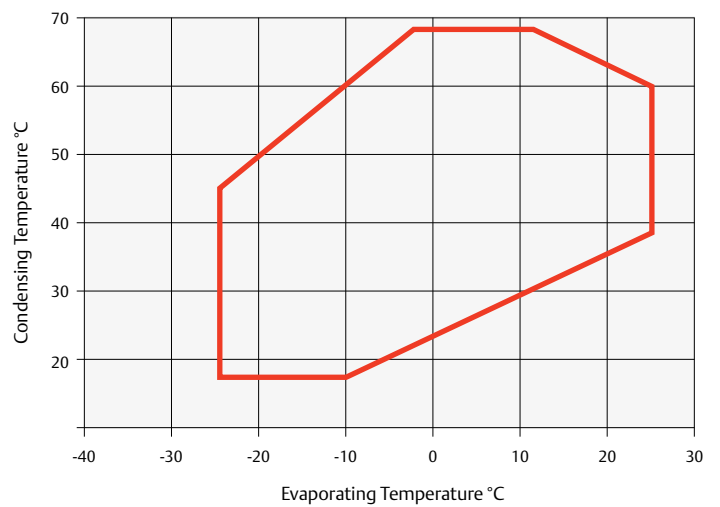

### ZH\*P (R410A) Line-Up

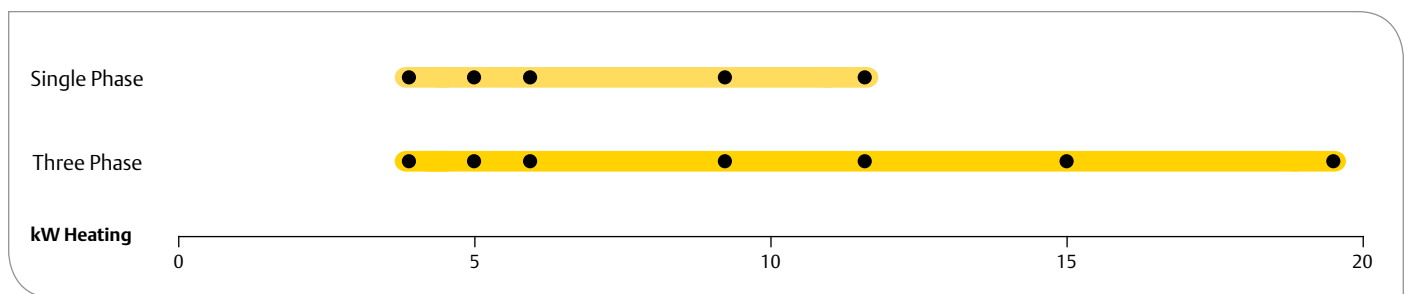

Conditions: heating kW -7/50 °C

# ZHI\*P Scroll Compressors With Vapor Injection

## Comfort In Average & Colder Climates

### Application

Whenever outstanding performance and reliability are required to retrofit boiler systems in high water temperature applications, ZHI\*P scrolls with Enhanced Vapor and Wet Injection are the solution.

ZHI\*P scrolls are suitable for air to water heat pumps, dedicated and reversible, for average and colder European climates. Thanks to vapor and wet injection, they feature a wide operating envelope which means they can reach high water temperatures (55-65°C) in colder climates.



ZHI\*P Copeland Scroll™ tandem

### Features and Benefits

- Full range of R410A compressors with up to 46 kW heating capacity
- Full range of Copeland qualified tandems with up to 92kW per circuit
- Enhanced Vapor Injection for up to 25% further heating capacity and up to 10% higher heating COP
- Wet Vapor Injection qualified to enable high water temperature production at very low evaporating temperatures
- Low sound and vibration level

### ZHI\*P (R410A) Envelope

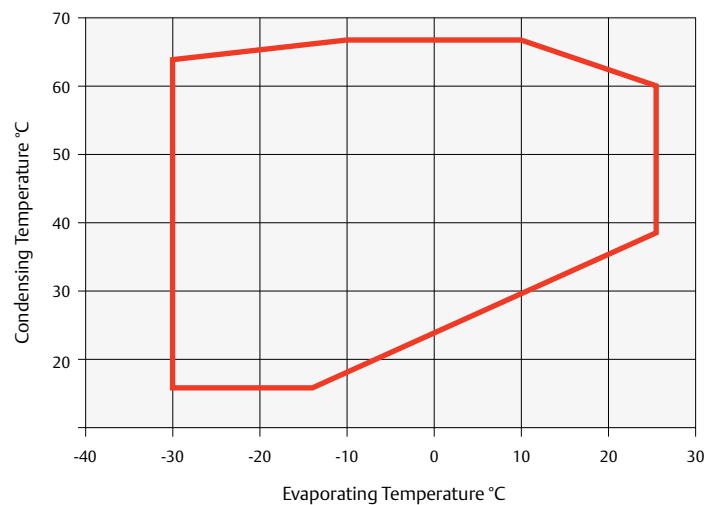

### ZHI\*P (R410A) with Enhanced Vapor Injection Line-Up

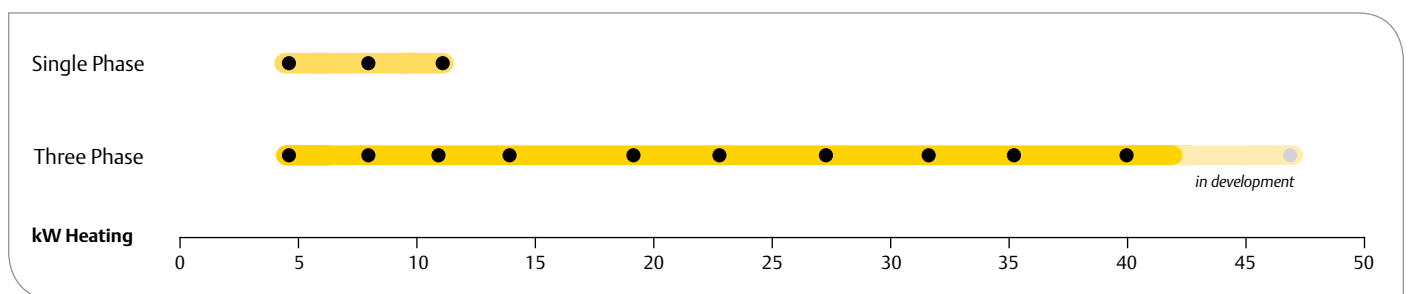

Conditions: heating kW -7/50 °C

# EXD-HP1/2 Superheat Controller

The Ideal Control For Heat Pumps Using Copeland Scroll Heating

## Application

Emerson EXD-HP1/2 controller can be used in various system configurations:

- As superheat controller of the main evaporator, both in single and double circuit systems
- As superheat controller of the main evaporator in conjunction with the economizer heat exchanger in a single circuit heat pump

## Features and Benefits

- Autotuning PID loop for superheat control of main evaporator and/or economizer
- Automatic switch from vapor to wet injection control for operating map extension (only ZHI\*P compressors)
- Compressor discharge hot gas temperature alarm
- Optimal start-up function
- RS485 serial communication to system controller (Modbus)
- Capable of up to 40bar MOPD with bi-flow function in conjunction with Emerson EXM/L electronic expansion valve
- Emerson Climate Technologies integrated solution

## Heat pump main evaporator and economizer superheat control by EXD-HP1/2

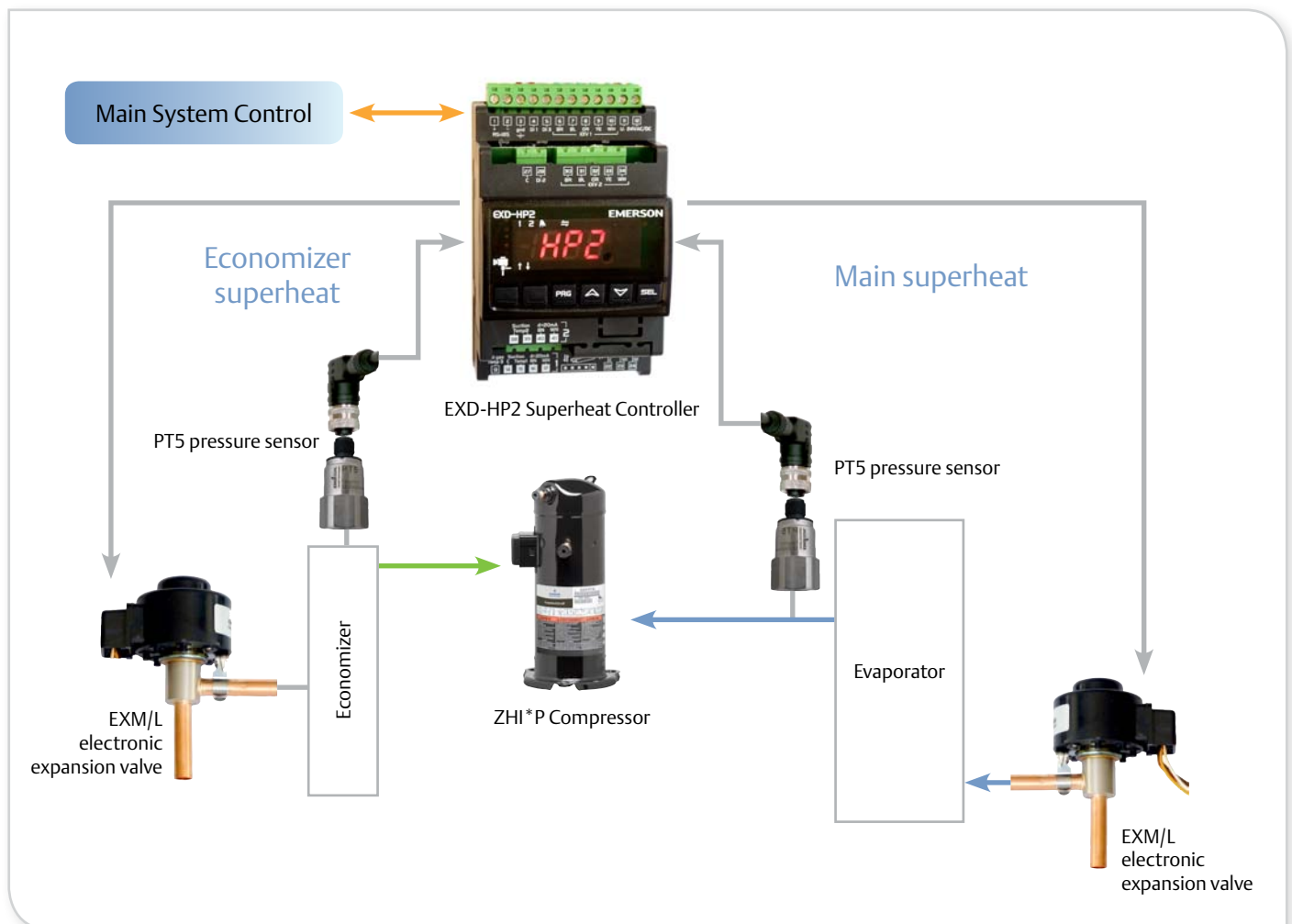

# EXD-TEVI Economizer Superheat Controller

## The Perfect Fit For Vapor Injection Control In Tandem Applications

### Application

Emerson EXD-TEVI is the state-of-the-art solution for a reliable and efficient economizer control of vapor and wet injection (only ZHI\*P compressors).

The EXD-TEVI controller can be used both in single and tandem applications, with residential and commercial scroll compressors.

### Features and Benefits

- Autotuning PID loop for superheat control of economizer cycle
- Automatic switch from vapor to wet injection control for operating map extension (only ZHI\*P compressors)
- Compressor discharge hot gas temperature alarm
- Optimal start-up function
- RS485 serial communication to system controller (Modbus)
- Capable of up to 40bar MOPD with bi-flow function in conjunction with Emerson EXM/L electronic expansion valves

### Economizer superheat control in a tandem scroll configuration by EXD-TEVI

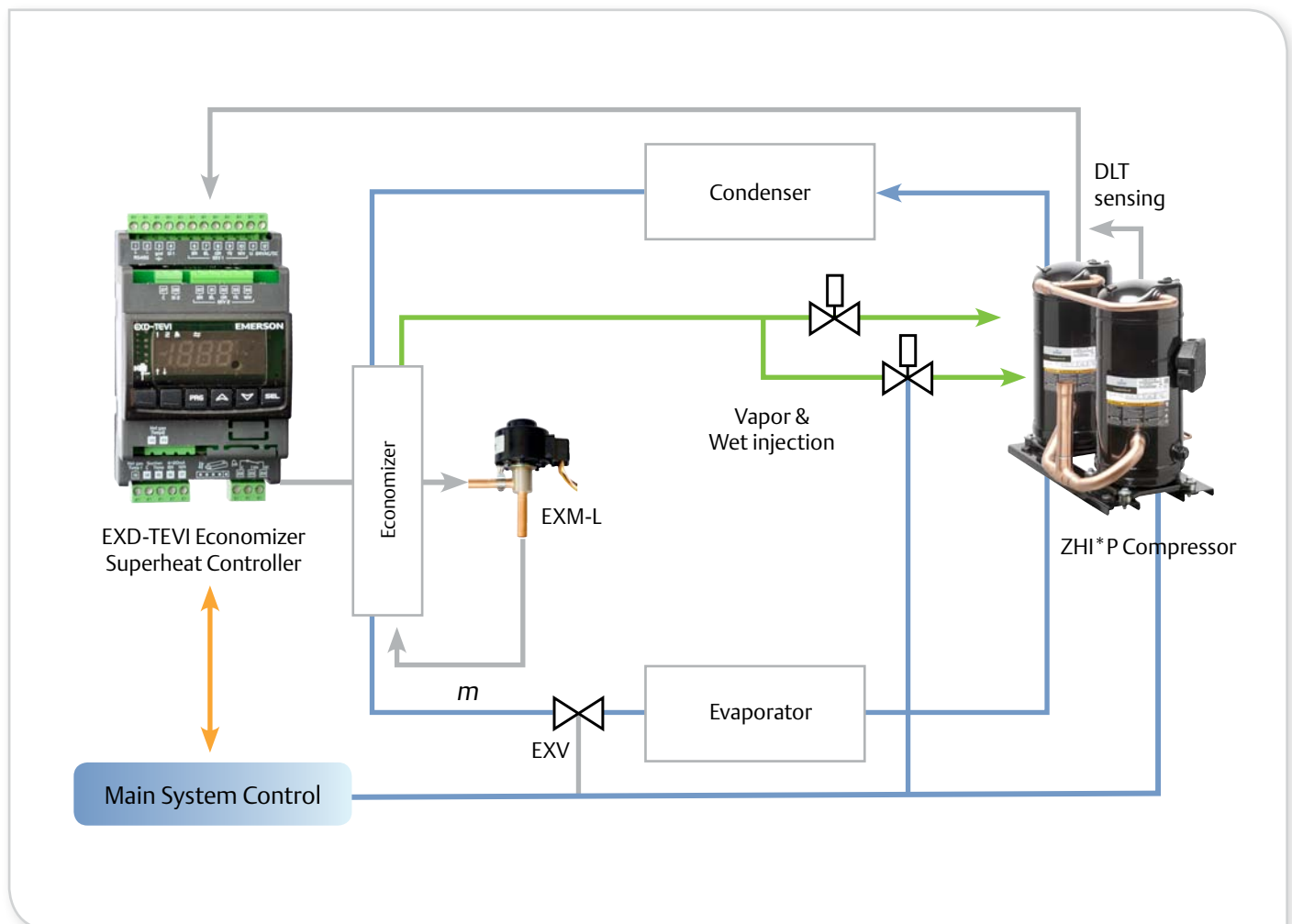



## Emerson Climate Technologies At A Glance

Emerson Climate Technologies is the world's leading provider of heating, ventilation, air conditioning, and refrigeration solutions for residential, industrial, and commercial applications. We combine technically superior products and services from

our industry-leading divisions and brands with our global engineering, design and distribution capabilities to create reliable, energy efficient climate systems that improve human comfort, safeguard food, and protect the environment.

TSC146-EN-1402

For more details, see [www.emersonclimate.eu](http://www.emersonclimate.eu)

**Emerson Climate Technologies GmbH - European Headquarters** - Pascalstrasse 65 - 52076 Aachen, Germany  
Tel. +49 (0) 2408 929 0 - Fax: +49 (0) 2408 929 570 - Internet: [www.emersonclimate.eu](http://www.emersonclimate.eu)

The Emerson Climate Technologies logo is a trademark and service mark of Emerson Electric Co. Emerson Climate Technologies Inc. is a subsidiary of Emerson Electric Co. Copeland is a registered trademark and Copeland Scroll is a trademark of Emerson Climate Technologies Inc.. All other trademarks are property of their respective owners. Emerson Climate Technologies GmbH shall not be liable for errors in the stated capacities, dimensions, etc., as well as typographic errors. Products, specifications, designs and technical data contained in this document are subject to modification by us without prior notice. Illustrations are not binding.  
© 2014 Emerson Climate Technologies, Inc.



**EMERSON. CONSIDER IT SOLVED.™**