

***Copeland®
EazyCool™***

***Copeland EazyCool™
outdoor condensing units***

Controller EC2-5X1

Application Guidelines

EMERSON™
Climate Technologies

1	Safety Instructions	3
1.1	ICON EXPLANATION	3
1.2	SAFETY STATEMENTS	3
2	Product Description	4
2.1	EC2-5X1 NOMENCLATURE	4
2.2	EC2-511 CONDENSING UNIT CONTROLLER	5
2.3	EC2-551 CONDENSING UNIT CONTROLLER	6
3	Display	7
3.1	NEURON ID / SERVICE BUTTON	7
3.2	LOAD DEFAULT PARAMETERS	7
4	Parameters	8
4.1	SELECT PARAMETER CONFIGURATION	8
4.2	PARAMETER MODIFICATION	8
4.3	SPECIAL FUNCTIONS	8
5	Indications on the Display	9
5.1	CONTROLLER 1	9
5.2	CONTROLLER 2	9
5.3	OTHER DISPLAY INDICATIONS	9
6	List of Parameters	9
6.1	CONTROLLER 1 (COMPRESSOR CAPACITY STAGING CONTROLLER)	10
6.2	CONTROLLER 2 (FAN CONTROLLER)	15
6.3	IMPORTANT PARAMETERS ON EC2-551	17
6.3.1	EC2-551 FOR TWO-COMPRESSOR UNITS WITH FAN SPEED CONTROLLER	17
6.3.2	EC2-551 FOR UNITS WITH COPELAND DIGITAL SCROLL COMPRESSOR	17
7	Alarms and Messages	18
7.1	ALARM CODES	18
7.2	MESSAGES	20
8	Technical Specifications	21
8.1	SAFETY STANDARD	21

1 Safety Instructions

1.1 Icon explanation



WARNING

This icon indicates instructions to avoid heavy personnel injuries and heavy material damage.



High Voltage

This icon indicates operations with a danger of an electric shock.



Danger of burning or frostbite

This icon indicates operations with a danger of burning or frostbite.



Explosion Hazard

This icon indicates operations with a danger of explosion.



CAUTION

This icon indicates instructions to avoid property damage without or with low personnel injuries.



IMPORTANT

This icon indicates instructions to avoid malfunction of the compressor.

NOTE this word indicates a recommendation for easier operations.

1.2 Safety statements

- Only qualified and authorised refrigeration personnel are allowed to do the installation, commissioning and maintenance.
- Qualified electrical personnel must connect the condensing unit and its accessories.
- All valid standards for connecting electrical and refrigeration equipment must be observed.

2 Product Description

The EC2-5X1 electronic condensing unit controller has been specially developed for the Copeland EazyCool™ condensing unit range.

The EC2-5X1 electronic condensing unit controller is mounted as standard in the following Copeland EazyCool™ condensing units:

- Copeland EazyCool™ stand alone two compressor condensing units: EC2-511
- Copeland EazyCool™ stand alone Digital Scroll™ condensing units: EC2-551
 - Single compressor condensing unit
 - Two compressor condensing unit
- Copeland EazyCool™ condensing units for refrigeration networks: EC2-551

The electronic controller enables:

1. Compressor modulation and/or staging based on suction pressure
2. LON (Local Operating Network) communication if connected to a PC with a LON interface installed, monitoring of operation parameters (pressures, temperatures as well as alarm states) becomes possible.
3. Fan speed control if an Alco Controls FSP150 fan speed driver is installed (available as a factory fitted option).

2.1 EC2-5X1 Nomenclature

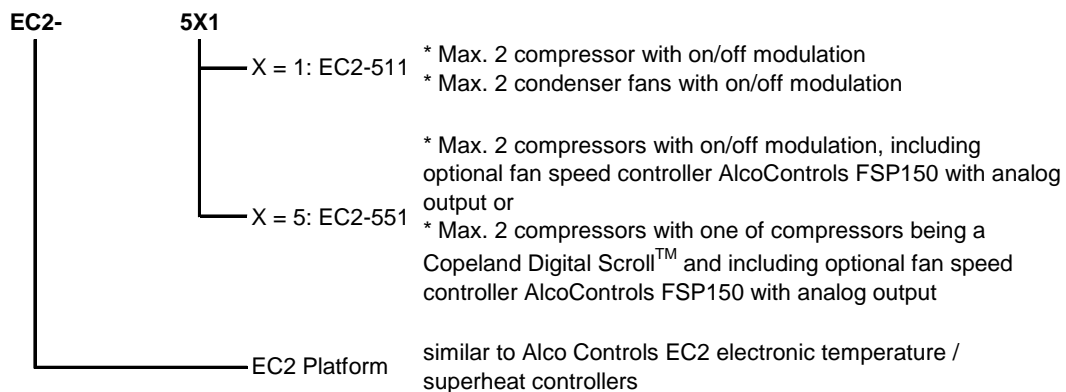

The next pages contain a description of these controllers and the parameters that can be changed. The controller has been pre-programmed with a number of parameter values that are most likely correct. Individual installation requirements however may make it necessary to alter parameter settings (e.g. suction pressure settings for compressor capacity staging, control dead band, refrigerant parameter).



High Voltage

Attention: Before carrying out work on the condensing unit, make sure that main power supply to the unit has been switched off!

2.2 EC2-511 Condensing Unit Controller

Copeland EazyCool™ condensing units with 2 compressors are equipped with an EC2-511 electronic Controller modulating compressors and fans in commercial refrigeration applications.

In fact there are two controllers present in the EC2-511 condensing unit controller:

- 1 (one) for controlling compressor capacity and,
- 1 (one) for controlling condenser pressure.

The control target of the **compressor controller** is to maintain the suction pressure at a defined value by varying the available compressor capacity based on the "ON/OFF" of the compressors (EC2-511 controller).

The control target for the **condenser controller** is to maintain the condensing pressure at a defined value by switching fans on/off on the Standard version (Two-compressor unit without fan speed controller - EC2-511 Controller)

For the **measurement** of the **suction pressure** and the **condensing pressure**, two Alco Controls PT4 pressure sensors with 4~20 mA interfaces are connected to the condensing unit controller.

The controller has:

- Four relay outputs; 2 for compressor control and 2 for fan control
- Three digital inputs for Volt-free input contacts are available
 - two of these are used for compressor serial alarm
 - the third - available for a fan serial alarm - is provided with a link, which should be removed, for use with an external serial alarm loop.

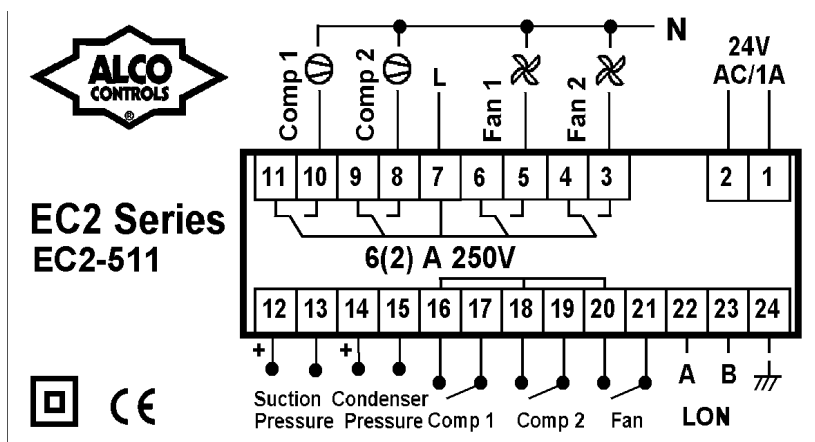

The **display** can show values with a decimal point in the range between -19.9 and +19.9 otherwise without decimal point.



An IR receiver for the optional IR remote control unit is built-in.

For communication purposes, an Echelon LONWorks® interface is provided (TP/FT-10 transceiver type).

The supply voltage is 24 V AC. A transformer for 230V main supply to 24 V AC is fitted in the Copeland EazyCool™ condensing unit electrical panel.

2.3 EC2-551 Condensing Unit Controller

The Condensing unit controller EC2-551 is fitted as standard on:

- Copeland EazyCool™ condensing units with Copeland Digital Scroll™ compressors
- Copeland EazyCool™ condensing units with two compressors and equipped with fan speed controller module Alco Controls FSP150 (optional).
- Copeland EazyCool™ condensing units for refrigeration networks

The condensing unit may have up to two compressors (of which one can be a Copeland Digital Scroll compressor) and 2 fans. Both fans can be fan speed controlled using a FSP 150 module (optional or fitted as standard, depending on the condensing unit model), using the analogue output of the EC2-551.

In fact there are two controllers present in the EC2-551 controller:

- one for controlling the compressor capacity, and
- one for controlling the condenser pressure.

The control target of the **compressor controller** is to maintain the suction pressure at a defined value by varying the available compressor capacity.

The control target for the **condenser controller** is to maintain the condensing pressure at a defined value by varying the fan speed.

For the **measurement** of the **suction pressure** and the **condensing pressure**, two Alco Controls PT4 pressure sensors with 4~20 mA interface can be connected to the controller.

The controller has:

- relay outputs to switch the compressors
- a 0-10V output to control the fan speed
- 1 Triac for modulation of the Copeland Digital Scroll compressor
- 3 digital inputs for Volt-free input contacts are available:
 - 2 for compressor serial alarm,
 - 1 for fan serial alarm.

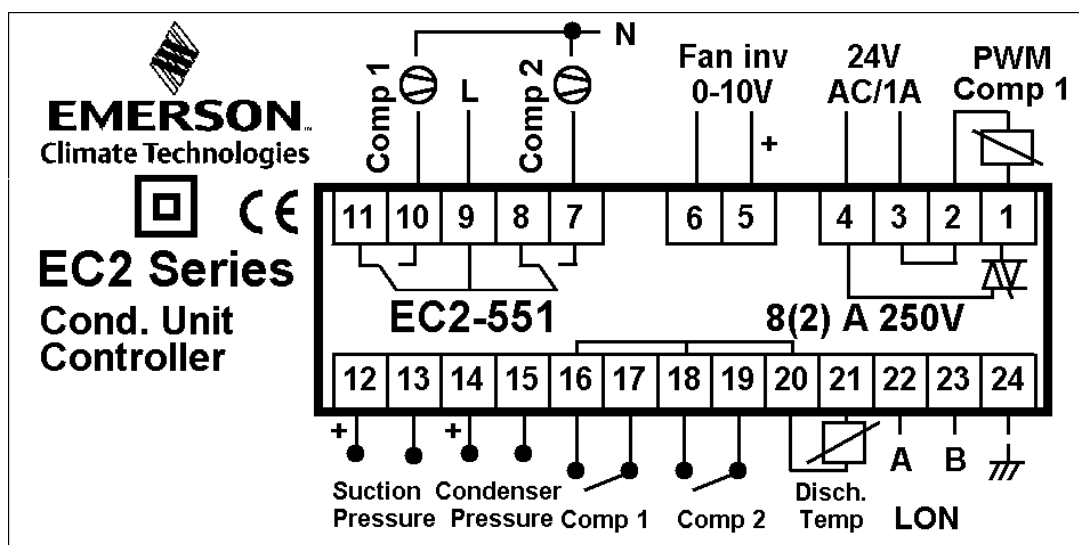

The **display** can show values with a decimal point in the range between -19.9 and +19.9 otherwise without decimal point.



An IR receiver for the optional IR remote control unit is build-in.
For communication purposes, an Echelon LONWorks® interface is provided with transceiver type FTT10A.
The supply voltage is 24 V AC. A transformer for 230V main supply to 24 V AC is fitted in the Copeland EazyCool™ condensing unit electrical panel.

3 Display

The data to be shown on the display can be selected by the user. In case of on alarm, the alarm code is displayed alternately with the selected data.

The data shown on the display are the compressors' and fans' states (default), the suction pressure, the saturation temperature from the suction pressure, the condensing pressure and the saturation temperature from condensing pressure.

To scroll through all possible displayable data press the **SEL** button. The display will show for one second the numerical identifier of the data and then the selected data. After 2 minutes the display will return to the selected data.

3.1 Neuron ID (unique 12 digit identity number, required for LON communication) / Service Button

Press the  button for approximately 1 second to send the Neuron ID.
An LED (Service) in the left upper corner will indicate the transmission of the Neuron ID.

3.2 Load Default Parameters

By pressing the service pin key  on the controller and switching on the power supply, the **EC2-551** will be reset to default parameters.

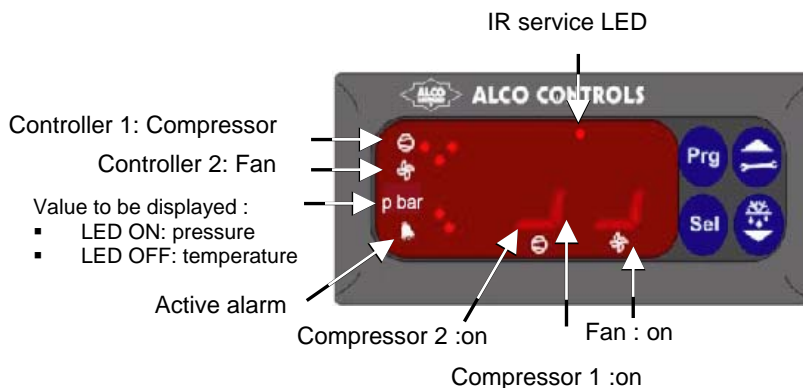

4 Parameters

4.1 Select parameter configuration



The configuration parameters can be protected by a numerical password. A value of "0" disables this protection (default password: 12). To select the parameter configuration:

- Press the **PRG** button for more than 5 seconds





In case of password value equal to "0":



- The first modifiable parameter code is displayed (/1).
- To modify parameters see "Parameter modification" below.

In case of password value not equal to "0":

- A flashing 0 is displayed
- Press  or  until the password value is displayed.
- Press **SEL** to confirm password
- The first modifiable parameter code is displayed (/1).
- To modify parameters see Parameters modification below.

4.2 Parameter Modification

- Press  or  to show the code of the parameter that has to be changed;
- Press **SEL** to display the selected parameter value;
- Press  or  to increase or decrease the value;
- Press **SEL** to temporally confirm the new value and display its code

Repeat the procedure from the beginning "press  or  to show..." to modify another parameter, etc.







To exit modifying the parameters with the new values:

- Press **PRG** to confirm the new values and exit the parameter modification procedure.

To exit without modifying any parameter:

- Do not press any button for at least 60 seconds (TIME OUT).

4.3 Special Functions

- Press  and  together for more than 5 seconds: a flashing "0" is displayed.
 - Press  or  until the password is displayed (default = 12). If password was changed, select the new password.
 - Then press **SEL** to confirm password
 - A "0" is displayed and the special function mode is activated.
 - Press  or  to select function (see list below)
 - Press **SEL** to activate the function and don't leave the special function mode.
 - Press **PRG** to activate the function and leave the special function mode.
- Most of the special functions work in a toggle mode, the first call activates the function and the second call deactivates the function. The indication of the function can only be displayed when the special function mode will be left.
- 0: display test function
3: resets all parameters to the default factory settings
1 & 2: not active for EC2-511 and EC2-551

5 Indications on the Display

EC2 controller includes 2 control modules, the first is dedicated for compressor(s) modulation (controller 1), the second is dedicated for fan(s) modulation (controller 2).

5.1 Controller 1

- Controller 1 state (compressor controller)
- Controller 1 alarm in combination with alarm message and alarm LED
- Suction pressure or saturation temperature from suction pressure
- Controller 1 parameter

5.2 Controller 2

- Controller 2 state (condenser fan controller).
- Controller 2 alarm in combination with alarm message and alarm LED
- Condensing pressure or saturation temperature from condensing pressure
- Controller 2 parameter

5.3 Other display indications

- Pressure: Pressure value in bar(g)
- Alarm: Alarm condition
- IR: IR communication enabled
- Service: Transmission of Neuron ID indicator

NOTE: Concerning the indicated parameters, it is recommended to check - before installing - if the factory value is suitable for the required use.

6 List of Parameters

Parameter		EC2-511				EC2-551			
		Min	Max	Unit	Def	Min	Max	Unit	Def
/	Display Parameters								
/1	Value to be shown on display	0	4	-	0	0	7	-	0

/1 Value to show on display

0 = compressors and fans states (controller 1 = Compressor(s), and controller 2 = Fan(s))

1 = suction pressure (bar(g))

2 = saturation temperature from suction pressure (°C)

3 = condensing pressure (bar(g))

4 = saturation temperature from condensing pressure (°C)

5 = Digital Scroll capacity (%)

6 = Fan speed (%)

7 = Digital Scroll discharge temperature (°C)

} Only for controller EC2-551

6.1 Controller 1 (Compressor capacity staging controller)

P	Parameter	EC2-511				EC2-551			
		Min	Max	Unit	Def	Min	Max	Unit	Def
P0	Pressure set-point (suction) for compressor circuit	-1.0	50.0	bar(g)	3.0	-1.0	50.0	bar(g)	3.0
P1	Pressure band (control band for P/PI, dead band for control mode)	0.0	50.0	bar	2.0	0.0	50.0	bar	2.0
P3	Fast recovery from low pressure	-9.9	50.0	bar(g)	-9.9	-9.9	50.0	bar(g)	-9.9
P8	High discharge pressure recovery	-9.9	50.0	bar(g)	50.0	-9.9	50.0	bar(g)	50.0

P0: Set point for modulation – should be fixed to the suction pressure required by installation.

P1: Dead band default setting point should be around 2 bar in medium temperature and should be reset to around 0.4 bar for low temperature. Dead band should be proportional to the pressure set point (i.e.: $P0 = 0.4 - P1 = 0.2$ or $P0 = 2 - P1 = 1$).

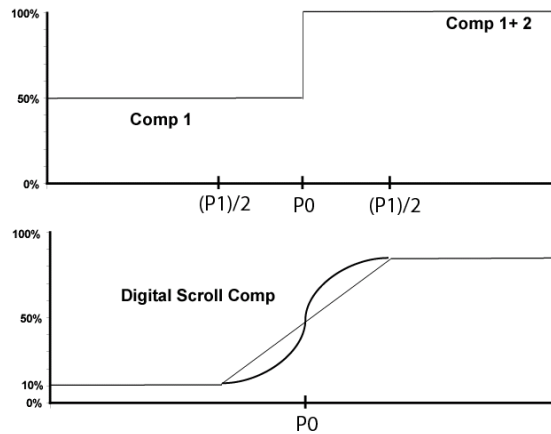

P3: This is a threshold to protect compressors from running at low suction pressures. When reached, all compressors are switched off instantly without obeying any delay times (not active by default). In case of activation, set point should be above the low-pressure switch setting.

P8: This is a threshold to protect the refrigeration system from running into high pressure limits. When limits are reached, if all compressors are running, one of the running compressors is switched off, if necessary without obeying of the delay times (not active by default). In case of activation, set point should be below the high pressure switch setting.

Parameter		EC2-511				EC2-551			
t	Time Parameters	Min	Max	Unit	Def	Min	Max	Unit	Def
t1 ¹⁾	Time delay before adding capacity	0	99	10sec	3	0	99	10sec	3
t2 ¹⁾	Time delay before removing capacity	0	99	10sec	3	0	99	10sec	3
t3 ¹⁾	Compressor minimum on time	0	99	10sec	6	0	99	10sec	6
t4 ¹⁾	Compressor minimum off time	0	99	10sec	6	0	99	10sec	6
t5	Maximum compressor switching	0	199	1/hr	0	0	199	1/hr	0

Parameter		EC2-511				EC2-551			
A	Alarm Parameters	Min	Max	Unit	Def	Min	Max	Unit	Def
A2	Minimum suction pressure alarm limit	-1.0	50.0	bar(g)	0.0	-1.0	50.0	bar(g)	0.0
A3	Maximum suction pressure alarm limit	-1.0	50.0	bar(g)	50.0	-1.0	50.0	bar(g)	50.0
A4 ¹⁾	Delay time for minimum pressure alarm limit	0	99	10sec	0	0	99	10sec	0
A5 ¹⁾	Delay time for maximum pressure alarm limit	0	99	10sec	0	0	99	10sec	0
A6	High discharge temperature cut-out (cut-in = cut out -10°C)	-	-	-	-	100	140	°C	130
A8 ¹⁾	Compressor serial alarm delay	0	99	10sec	0	0	99	10sec	0
A9 ²⁾	Compressor run limit before Maintenance	0	99	10k Hr	0	0	99	10k Hr	0

¹⁾ Value shown in display is 10 times lower

²⁾ These values have a resolution of 10.000 hours, on the local display. Example: value 1 means 10.000 hours.

A2: Minimum limit for suction pressure alarm – Value will be fixed on same value than the mechanical LP safety switch

A3: Maximum limit for suction pressure alarm – Inactive by default

*If this function is active and the suction pressure is above the maximum value A3, an **hP1** alarm signal will appear, followed by the measured pressure value. It is important to know that the alarm signal will stay until temperature decreases and suction pressure stabilises below maximum value A3.*

A6: High discharge temperature cut-out for Digital Scroll compressor only – fixed at 130°C

Parameter		EC2-511				EC2-551			
u	Step enable Parameters	Min	Max	Unit	Def	Min	Max	Unit	Def
u0	Reset operating time	0	3	-	0	0	3	-	0
u1	Enable/disable compressor 1	0	1	flag	1	0	1	flag	1
u2	Enable/disable compressor 2	0	1	flag	1	0	1	flag	1

u0 Compressor reset operating time

0 = do nothing

1 = reset operating time compressor 1

2 = reset operating time compressor 2

3 = reset operating time all compressors

c	Parameter	EC2-511				EC2-551			
		Min	Max	Unit	Def	Min	Max	Unit	Def
	Application Parameters								
c1	Number of compressors	1	2	-	2	1	2	-	2
c3	Control mode (network system)	2	3	-	2	2	3	-	2
c4	Compressor 1 control mode	0	1	-	0	0	2	-	0
c5	Compressor switch logic	0	1	flag	1	0	1	flag	1
c6	Number of compressor to switch on in case of sensor failure	0	2	-	0	0	2	-	0

c1 Number of compressors

This default parameter is set to 2 for two-compressor Copeland EazyCool™ condensing units.

For single-compressor Copeland EazyCool™ condensing units with Copeland Digital Scroll™, c1 should be changed to 1.

c3 Control mode

This parameter is not active for stand alone units, it only applies to units used in refrigeration networks.

c4 Compressor 1 control mode

0 = compressor 1 in standard control loop

1 = compressor 1 act as base load compressor

2 = compressor 1 act as modulating (PWM control for Copeland Digital Scroll™ compressor only - not in use for EC2-511)

c5 Compressor switch logic

0 = FILO logic (FILO = First In, Last Out)

- Capacity demand: adds first compressor out of available compressors. (available compressors: compressors where min off time (t3) is fulfilled)
- Capacity excess: removes last compressor out of available compressors. (available compressors: compressors where min on time (t4) is fulfilled)

1 = Rotation enabled, FIFO logic (FIFO = First In, First Out)

- Capacity demand: adds compressor with lowest runtime out of available compressors. (available compressors: compressors where min off time (t3) is fulfilled)
- Capacity excess: removes compressor with highest runtimes out of available compressors. (available compressors: compressors where min on time (t4) is fulfilled)

c6 Number of compressor to switch on in case of sensor failure

Compressor(s) will be switched on and run only. Suction pressure control by LP switch, system protected by the mechanical safety devices (HP & LP switches).

r	Parameter	EC2-511				EC2-551			
		Min	Max	Unit	Def	Min	Max	Unit	Def
	Sensor Parameters								
r0	Suction pressure sensor min. value	-1.0	50.0	bar	-0.8	-1.0	50.0	bar	-0.8
r1	Suction pressure sensor max. value	-1.0	50.0	bar	7.0	-1.0	50.0	bar	7.0
r2	Pressure offset for suction pressure	-1.0	1.0	bar	0.0	-1.0	1.0	bar	0.0
r3	Refrigerant type	0	5	-	4	0	5	-	4

r0 & r1 parameters setting value depends of the refrigerant choice "r3".

r3 is set as default for R404A.

r3 Refrigerant

0 = no temperature conversion

1 = R22

2 = R134a (not possible for units including Copeland Digital Scroll compressors)

3 = R507

4 = R404A

5 = R407C (not possible for units including Copeland Digital Scroll compressors)

NOTE: R134a cannot be used for Copeland EazyCool™ condensing units with two compressors, as LP and HP switch are not set for R134a.

F	Parameter	EC2-511				EC2-551			
		Min	Max	Unit	Def	Min	Max	Unit	Def
F2	Minimum output value	-	-	-	-	10.0	100.0	%	20.0
F3	Maximum output value	-	-	-	-	10.0	100.0	%	100.0
F6	PWM rate (Digital Scroll compressor)	-	-	-	-	10	20	sec	20

Modulation range of Copeland Digital Scroll compressor:

- **F2** will set minimum capacity of Copeland Digital Scroll compressor
Minimum capacity: F2 => 10%
With a two compressor unit, a small capacity step occurs when the second compressor starts: capacity when second compressors starts= 50% (fixed capacity compressor) + F2/2 Digital Scroll compressor capacity
- **F3** will set max capacity: with F3 = 80%, compressor will pump during max 80% of the 20 sec cycle, so max 16 seconds.

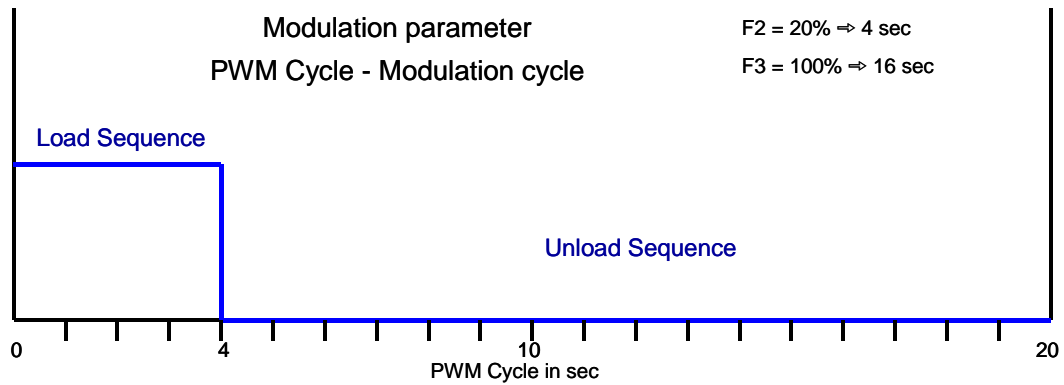

F6: The Pulse Width Modulated signal (PWM signal) is the modulation period of a Copeland Digital Scroll compressor which can be adjusted from 10 to 20 seconds to ensure the closest modulation time period.

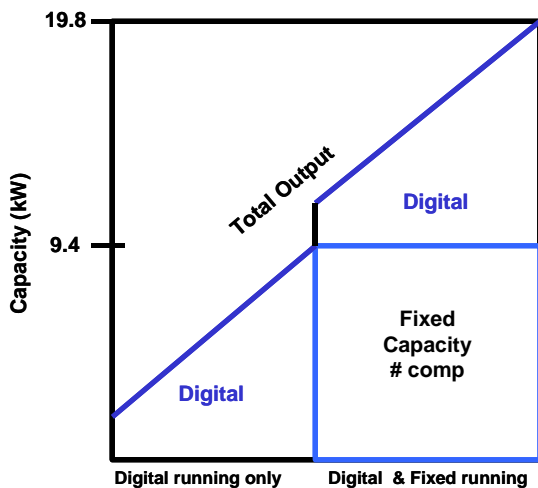

Digital running only Digital & Fixed running
Example OMTQ-90D
1 Digital Comp with F2 = 20% & F3 = 100%
1 fixed capacity comp

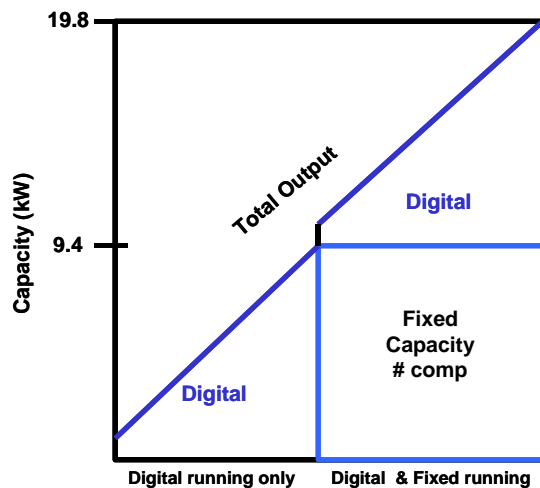

Digital running only Digital & Fixed running
Example OMTQ-90D
1 Digital Comp with F2 = 10% & F3 = 100%
1 fixed capacity comp

6.2 Controller 2 (Fan controller)

Two compressor Copeland EazyCool™ condensing units without fan speed controller are equipped with EC2-511, controller 2 is switching fan “ON/OFF”.

Two compressor Copeland EazyCool™ condensing units with fan speed controller (option) as well as a two compressor Copeland EazyCool™ condensing units including a Copeland Digital Scroll™ compressor are equipped with EC2-551, controller 2 is modulating fan(s) speed.

Parameter		EC2-511				EC2-551			
P	Set Point Parameters	Min	Max	Unit	Def	Min	Max	Unit	Def
P0	Pressure set-point (condensing) for fan circuit	-1.0	50.0	bar(g)	14.0	-1.0	50.0	bar(g)	14.0
P1	Pressure band (control band for P/PI, dead band for control mode)	0.0	50.0	bar	4.0	0.0	50.0	bar	4.0
P3	Fast recovery from low pressure	-9.9	50.0	bar(g)	-9.9	-	-	-	-

P0: Set point for fan modulation

P1: Dead band default setting point is 4 bar.

Parameter		EC2-511				EC2-551			
t	Time Parameters	Min	Max	Unit	Def	Min	Max	Unit	Def
t1 ¹⁾	Time delay before adding fan(s)	0	99	10sec	3	-	-	-	-
t2 ¹⁾	Time delay before removing fan(s)	0	99	10sec	3	-	-	-	-

Parameter		EC2-511				EC2-551			
A	Alarm Parameters	Min	Max	Unit	Def	Min	Max	Unit	Def
A2	Minimum condensing pressure alarm limit	-1.0	50.0	bar(g)	10.0	-1.0	50.0	bar(g)	10.0
A3	Maximum condensing pressure alarm limit	-1.0	50.0	bar(g)	27.0	-1.0	50.0	bar(g)	27.0
A4 ¹⁾	Delay time for minimum pressure alarm limit	0	990	10sec	0	0	990	10sec	0
A5 ¹⁾	Delay time for maximum pressure alarm limit	0	990	10sec	0	0	990	10sec	0
A8 ¹⁾	Fan serial alarm delay	0	990	10sec	0	0	990	10sec	0
A9 ²⁾	Fan run limit	0	990	k Hr	0	0	990	k Hr	0

¹⁾ Value shown in display is 10 times lower

²⁾ These values have a resolution of 10.000 hours, on the local display. Example: value 1 means 10.000 hours.

Parameter		EC2-511				EC2-551			
u	Step enable Parameters	Min	Max	Unit	Def	Min	Max	Unit	Def
u0	Reset operating time	0	1	-	0	0	1	-	0
u1	Enable/disable fan1	0	1	flag	1	0	1	flag	1
u2	Enable/disable fan2	0	1	flag	1	-	-	-	-

u0 Fan Reset operating time

0 = do nothing

1 = reset operating time fan 1

2 = reset operating time fan 2

u1 & u2 Enable/Disable fan

Disconnect one of the two fans in case of fan break-down

Parameter		EC2-511				EC2-551			
c	Application Parameters	Min	Max	Unit	Def	Min	Max	Unit	Def
c1	Number of fans	1	2	-	2	-	-	-	-
c3	Control mode (dead band)	2	2	-	2	-	-	-	-
c5	Fan switch logic (Rotation)	0	1	flag	1	-	-	-	-
c6	Number of fans to switch on in case of sensor failure	0	2	-	0	0	1	-	0

Parameter		EC2-511				EC2-551			
r	Sensor Parameters	Min	Max	Unit	Def	Min	Max	Unit	Def
r0	Condensing pressure sensor min. value	-1.0	50.0	bar	0.0	-1.0	50.0	bar	0.0
r1	Condensing pressure sensor max. value	-1.0	50.0	bar	30.0	-1.0	50.0	bar	30.0
r2	Pressure offset for condensing pressure	-1	1	bar	0	-1	1	bar	0

Parameter		EC2-511				EC2-551			
H	Other Parameters	Min	Max	Unit	Def	Min	Max	Unit	Def
H2	Keyboard and IR Remote Control	0	3	-	3	0	3	-	3
H3	IR Remote control access code	0	199	-	0	0	199	-	0
H5	Password	0	199	-	12	0	199	-	12

Parameter		EC2-511				EC2-551			
F	Modulating Parameters	Min	Max	Unit	Def	Min	Max	Unit	Def
F2	Minimum output value	-	-	-	-	0.0	100.0	%	0.0
F3	Maximum output value	-	-	-	-	0.0	100.0	%	100.0

H2 Keyboard and IR remote control

0 = all disabled (Caution, access to controller only via LON network possible)

1 = Keyboard enabled

2 = IR remote control enabled

3 = Keyboard and IR remote control enabled

6.3 Important parameters on EC2-551 to configure according to Copeland EazyCool™ model

6.3.1 EC2-551 for Copeland EazyCool™ condensing unit with two compressors with fan speed controller FSP150

Major parameters for operation

c	Parameter	EC2-551			
		Min	Max	Unit	Def
c	Application Parameters				
c1	Number of compressors	1	2	-	2
c3	Control mode (network system)	2	3	-	2
c4	Compressor 1 control mode	0	2	flag	0
c5	Compressor switch logic	0	1	flag	1
c6	Number of compressor to switch on in case of sensor failure	0	2	-	0

c4 Compressor 1 control mode

0 = compressor 1 in standard control loop

1 = compressor 1 act as base load compressor

2 = compressor 1 act as modulating (**PWM control for Copeland Digital Scroll™ compressor only**)

NOTE: c4 parameter should be either 0 or 1

6.3.2 EC2-551 for Copeland EazyCool™ condensing unit with Copeland Digital Scroll compressor

Major parameters for operation

c	Parameter	EC2-551			
		Min	Max	Unit	Def
c	Application Parameters				
c1	Number of compressors	1	2	-	2
c3	Control mode (network system)	2	3	-	2
c4	Compressor 1 control mode	0	2	flag	2
c5	Compressor switch logic	0	1	flag	1
c6	Number of compressor to switch on in case of sensor failure	0	2	-	0

c4 Compressor 1 control mode

0 = compressor 1 in standard control loop

1 = compressor 1 act as base load compressor

2 = compressor 1 act as modulating (**PWM control for Copeland Digital Scroll™ compressor only**)

NOTE: For a digital condensing unit c4 should only be fixed on "2"

Parameter		EC2-551			
F	Modulating Parameters	Min	Max	Unit	Def
F2	Minimum output value	10	100	%	20
F3	Maximum output value	10	100	%	100

Minimum & Maximum output value could be adjusted

In case of a single compressor Copeland EazyCool™ condensing unit with a Copeland Digital Scroll compressor, the maximum output could be set below 100% if system requests less than the maximum capacity. In that case **F3 > F2**.

7 Alarms and Messages

7.1 Alarm codes

hP High pressure alarm signal flashing before indicating the actual pressure value of the system

- Controller 1: suction pressure higher than the maximum limit A3 (inactive by default)
- Controller 2: condensing pressure higher than the maximum limit A3

Alarm during the pull down period in case A3 is fixed around 6 bar:

During the pull down period, alarm hP1 will be flashing until the condensing unit reaches a value below the A3 set-point (by default 6 bar).

Pull down curve

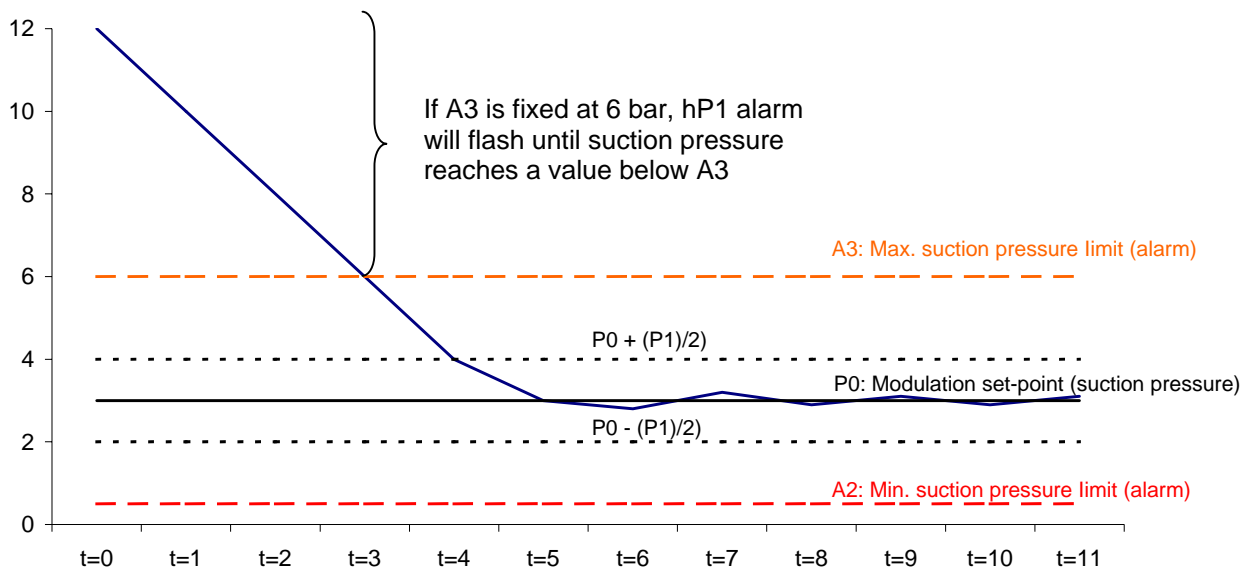

IP Low pressure alarm signal flashing before indicating the actual pressure value of the system

- Controller 1: suction pressure lower than the minimum limit A2 (0 bar by default)
- Controller 2: condensing pressure lower than the minimum limit A2

EP Error pressure

- Controller 1: suction pressure sensor failure
- Controller 2: condensing pressure sensor failure

Fr Fast recovery alarm (if P3 active) signal flashing before indicating the actual pressure value

- Controller 1: fast recovery from low suction pressure. Signal just before compressor stops.
- Controller 2: fast recovery from low condensing pressure (only for EC-2-511 if active). Signal just before fan stops.

hr High discharge pressure alarm (if P8 active) signal flashing before indicating the actual pressure value

- Controller 1: high discharge pressure recovery

Emergency run

- Controller 1: runs with c6 numbers of compressors
- Controller 2: runs with c6 numbers of fans

cE Communication error

- Controller 1: Communication error if binding for paralleling is used. A slave controller then goes to emergency master mode and works with local pressure sensor and set point.

d1 Discharge temperature alarm

- Digital Scroll compressor only: Discharge end temperature is too high – compressor stop.

E1 Feedback alarm 1 – safety loop failure of compressor 1 (safety loop, HP or LP pressure switches, or oil level control)

- Controller 1: digital input associated with compressor 1 has changed into alarm state (safety chain)

E2 Feedback alarm 2 – safety loop failure of compressor 2 (safety loop, HP or LP pressure switches, or oil level control)

n1 Service alarm 1

- Controller 1: compressor 1 operating time higher than service limit
- Controller 2: fan 1 operating time higher than service limit

n2 Service alarm 2

- Controller 1: compressor 2 operating time higher than service limit
- Controller 2: fan 2 operating time higher than service limit

Er Data error

- Data send to the display is out of range

7.2 Messages

- In** Configuration data initialisation
- The display will show an “In” when the configuration data are initialised with the factory default values.
- Id** Wink request received
- The display will show a flashing “Id” when the wink request was received. The node will receive the flashing “Id” will be shown on the display until the service button will be pressed, or a 30 min delay timer will expire or a second wink request. (NEURON ID)
- oF** Offline
- The node is offline: no application is running. This is the result of a network management command.
- - - - Controller disabled, waiting for restart
- After a major change of the configuration parameter, the compressor capacity controller and the condenser fan controller are disabled for 20 seconds. After this delay the controllers restart automatically.
 - The compressor controller and the condenser controller are disabled.

8 Technical Specifications

Enclosure	
Operating	0 / +50°C or 32 / +122°F
Storage-	-10 / +70°C or 14 / +158°F
Power supply:	24 V AC, -15%, +10%
Consumption:	12 VA
Case:	Auto extinguishing Plastic, 75 x 33 x 73 mm
Mounting:	
Controller;	Panel mounting
Connections:	Plug in connectors for cables of max. 1.5 mm ² , min. 0.5 mm ² section
Display:	2½ digits
Indicators LED:	Controller 1, controller 2, pressure, IR activated, alarm & neuron ID
Inputs:	Feedback failure contact for compressor 1 to 2.
Pressure sensor:	2 x 4- 20 mA (2 wires)
Outputs:	2 x Relays SPDT I _{max} = 8A res (2A), V AC max = 250V : Compressor relays 1 to 2, 1 x Triac for 24 V AC Solenoid 1 x 0-10V Analog output
Environmental pollution	non aggressive atmosphere
Protection class	IP65 (frontal protection with gasket)
Insulation	class II



IMPORTANT

Keep controller and sensor lines separated from mains cable with at least 3 cm.

NOTE When cleaning the display use damp cloth and neutral detergent

8.1 Safety Standard

In order to comply the safety standard (CEI 107-70) see the following:

1. Connection cables should be suitable for 90°C operation.
2. Class II transformers 24 V AC double insulated has been used

BENELUX

Deltakade 7
NL-5928 PX Venlo
Tel. +31 77 324 02 34
Fax +31 77 324 02 35
benelux.sales@emerson.com

UK & IRELAND

Unit 17, Theale Lakes Business Park
Reading, Berks RG7 4GB
Tel: +44 1189 83 80 00
Fax: +44 1189 83 80 01
uk.sales@emerson.com

BALKAN

Selska cesta 93
HR-10 000 Zagreb
Tel. +385 1 560 38 75
Fax +385 1 560 38 79
balkan.sales@emerson.com

GERMANY, AUSTRIA & SWITZERLAND

Senefelder Str. 3
DE-63477 Maintal
Tel. +49 6109 605 90
Fax +49 6109 60 59 40
ECTGermany.sales@emerson.com

SWEDEN, DENMARK, NORWAY & FINLAND

Pascalstr. 65
DE-52076 Aachen
Tel. +49 2408 929 0
Fax +49 2408 92 95 28
nordic.sales@emerson.com

UKRAINE

Turgenevskaya Str. 15, office 33
UA-01054, Kiev
Tel. +38 - 44 - 4 92 99 24
Fax. +38 - 44 - 4 92 99 28
Andrey.Gladchenko@emerson.com

FRANCE, GREECE & MAGHREB

8, Allée du Moulin Berger
FR-69130 Ecully Cédex
Tel. +33 4 78 66 85 70
Fax +33 4 78 66 85 71
mediterranean.sales@emerson.com

EASTERN EUROPE & TURKEY

Pascalstr. 65
DE-52076 Aachen
Tel. +49 2408 929 0
Fax +49 2408 929 525
easterneurope.sales@emerson.com

ROMANIA

Tel. +40 - 364 - 73 11 72
Fax. +40 - 364 - 73 12 98
Camelia.Tiru@emerson.com

ITALY

Via Ramazzotti, 26
IT-21047 Saronno (VA)
Tel. +39 02 96 17 81
Fax +39 02 96 17 88 88
italy.sales@emerson.com

POLAND

Szturmowa 2
PL-02678 Warsaw
Tel. +48 22 458 92 05
Fax +48 22 458 92 55
poland.sales@emerson.com

MIDDLE EAST & AFRICA

PO Box 26382
Jebel Ali Free Zone - South, Dubai - UAE
Tel. +971 4 811 81 00
Fax +971 4 886 54 65
mea.sales@emerson.com

SPAIN & PORTUGAL

C/ LLull, 321 (Edifici CINC)
ES-08019 Barcelona
Tel. +34 93 412 37 52
Fax +34 93 412 42 15
iberica.sales@emerson.com

RUSSIA & CIS

Letnikovskaya 10, Bld. 2, floor 5
RU-115114 Moscow
Tel. +7 495 981 98 11
Fax +7 495 981 98 16
ECT.Holod@emerson.com

For more details, see www.emersonclimate.eu

Emerson Climate Technologies - European Headquarters - Pascalstrasse 65 - 52076 Aachen, Germany
Phone: +49 (0) 2408 929 0 - Fax: +49 (0) 2408 929 570 - Internet: www.emersonclimate.eu

The Emerson Climate Technologies logo is a trademark and service mark of Emerson Electric Co. Emerson Climate Technologies Inc. is a subsidiary of Emerson Electric Co. Copeland is a registered trademark and Copeland Scroll is a trademark of Emerson Climate Technologies Inc.. All other trademarks are property of their respective owners. Information contained in this brochure is subject to change without notification.

© 2011 Emerson Climate Technologies, Inc.



EMERSON
Climate Technologies

EMERSON. CONSIDER IT SOLVED.™