

EXD-SH1/2 Controller for EX/FX/CX with ModBus Communication Capability

Technical Bulletin

EXD-SH1/2 are stand-alone universal superheat and or temperature controllers for air conditioning units or refrigeration systems.

Features

- EXD-SH1: Control of one valve
- EXD-SH2: Control of two valves in two independent circuits
- Main function

	Circuit 1	Circuit 2
EXD-SH1	Superheat or temperature control	
EXD-SH2	Superheat or temperature control	Superheat Control

- Other functions: Limitation of evaporating pressure (MOP), Low pressure switch, freeze protection and manual positioning of valve(s)
- Self-adapting superheat control function in conjunction with EMERSON FX5-9, EX4-8 and CX4-7 series
- For multiple refrigerants, including ultralow temperature refrigerant R23
- Modbus (RTU) communication
- Integrated keyboard with two lines display
- Monitoring of sensors and detection of sensor (ECN/PT5/6) /stepper motor wiring failures
- Optional upload/download key (accessory) for transmission of parameter settings among controllers with the same setting
- Low/high superheat alarm as well as other function alarms
- Electrical connection via plug-in type screw terminals included with controller and Micro Molex EXD-M05 (must be ordered separately)
- DIN rail mounting housing



EXD-SH2



EXD-M03

Selection table

Type	Description	Part No.	
		Multipack	Single pack
Controllers			
EXD-SH1	Controller for single refrigeration circuit	-	807855
EXD-SH2	Controller for two independent refrigeration circuits	-	807856
EXD-M03	Molex terminal with 3 meter wires	-	807865
ECN-N30	Temperature sensor with 3 meter cable	-	804496
ECN-N60	Temperature sensor with 6 meter cable	-	804497
ECN-Z60	Ultralow Temperature sensor with 6 meter cable	-	807826
Pressure transmitters: PT5/PT6 (7/16-20UNF connection)			
PT5-07M	Sensing pressure range -0.8 to 7 bar	802350M	802350
PT5-18M	Sensing pressure range 0 to 18 bar	802351M	802351
PT5-30M	Sensing pressure range 0 to 30 bar	802352M	802352
PT5-50M	Sensing pressure range 0 to 50 bar	802353M	802353
PT5-150D	Sensing pressure range 0 to 150 bar (1/4 NPTF)	-	802379
PT6-18M	Sensing pressure range 0 to 18 bar	802361M	-
PT6-30M	Sensing pressure range 0 to 30 bar	802362M	-
PT6-50M	Sensing pressure range 0 to 50 bar	802363M	-
Pressure transmitters: PT5 (Brazing connection)			
PT5-07T	Sensing pressure range -0.8 to 7 bar	802380M	802380
PT5-18T	Sensing pressure range 0 to 18 bar	802381M	802381
PT5-30T	Sensing pressure range 0 to 30 bar	802382M	802382
PT5-50T	Sensing pressure range 0 to 50 bar	802383M	802383

Note: Pressure range 18 bar for system with R410A, 30 bar for R410A economizer, 50/150 bar for CO₂
 PT5-xxM Multipack = 20 pcs, PT5-xxT Multipack = 10pcs

EXD-SH1/2 Controller with ModBus Communication Capability

Accessories

Type	Description	Part No.	
		Multipack (20 pieces)	Single pack
M12 Plug and cable for pressure transmitters PT5/PT6			
PT4-M15	1.5 m	804803M	804803
PT4-M30	3.0 m	804804M	804804
PT4-M60	6.0 m	804805M	804805
Uninterruptible Power supply			
ECP-024	Backup battery with two outputs for two controllers	-	804558
K09-P00	Electrical Terminal Kit for ECP-024	-	804560
EXD-PM	Super cap for only EXD-SH1 (two pieces of EXD-PM required for one EXD-SH2)	↑ -	807854

Description of functions

Controllers are featured with a main function as superheat controller or temperature controller. The main function is selectable.

Superheat control of evaporators or economizers

This function requires the connection of temperature sensor(s) as well as pressure transmitters(s). The other functions are:

- MOP control: enables the limitation of saturated temperature of suction line (outlet of evaporator/economizer)
- Low pressure behaves similar to low pressure switch including alarm conditions
- Freeze protection is based on saturated temperature from converting measuring suction pressure. It provides alarm condition below certain adjusted temperature.

Temperature controller

The function is to maintain desired temperature by modulating refrigerant mass flow. If controller is operated as temperature controller, the connection of pressure transmitter is not required.

In order to fulfill varieties of the applications, the refrigerant mass flow variation can be set according temperature increase or decrease.

**Temperature control in normal sense
(A: Mass flow increases if temperature rises)**

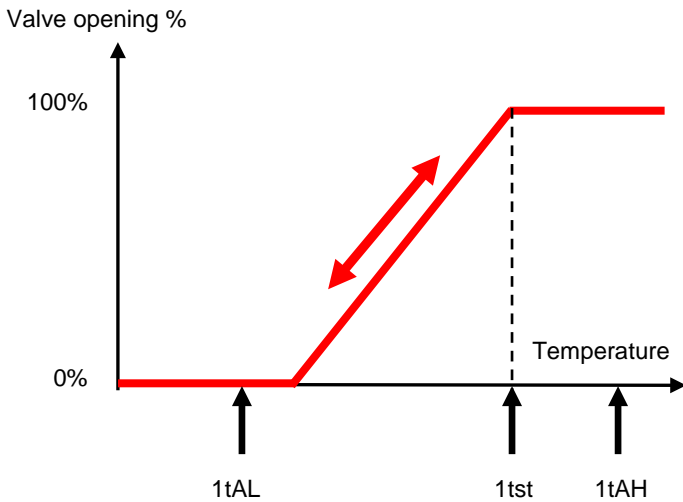

**Temperature control in reverse sense
(B: Mass flow decreases if temperature rises)**

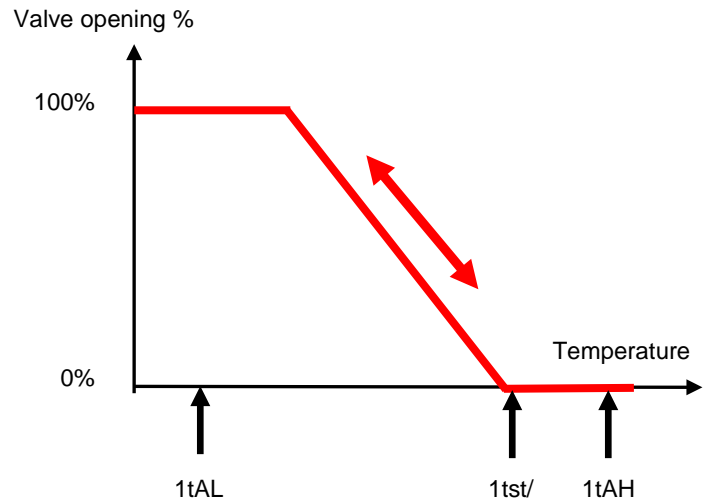

Examples of applications:

- Temperature control by throttling suction mass flow (normal sense, A)
- Temperature control by modulating hot gas into inlet or outlet of evaporators (reverse sense, B)
- Discharge temperature control by injecting liquid (normal sense, A)
- Head pressure control by means of temperature control (normal sense, A)

EXD-SH1/2 Controller with ModBus Communication Capability

Wiring

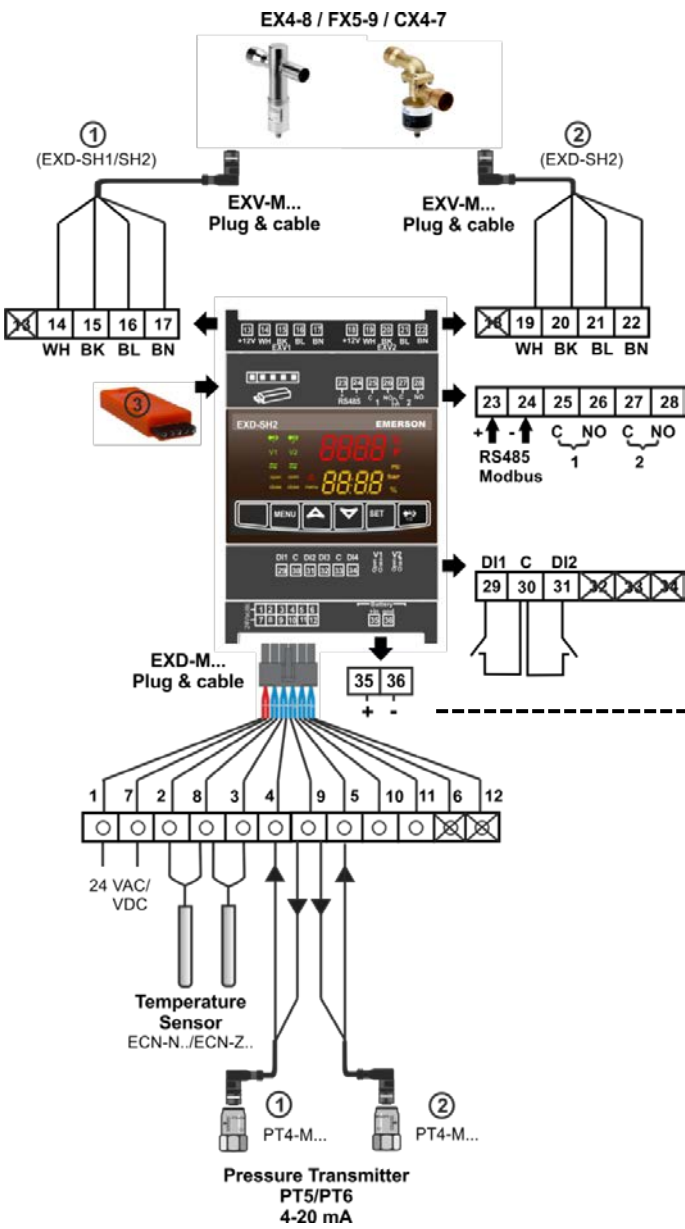

Wiring options: UPS (ECP-024) /Supercap (EXD-PM)

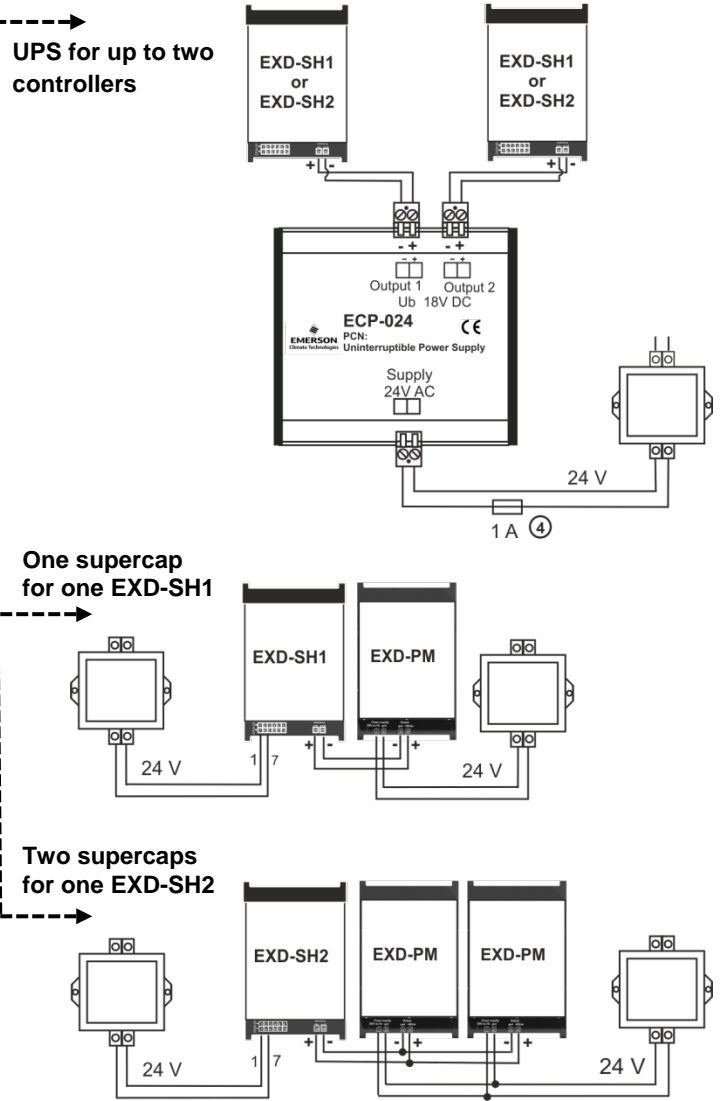

①	Circuit 1 (EXD-SH1/SH2)	14-17	Electronic expansion valve circuit 1 EXV-M... Electrical plug: wire colors WH-white BK-black BL-blue BN-brown
②	Circuit 2 (EXD-SH2)		
③	Download/upload key	19-22	Electronic expansion valve circuit 2 EXV-M... Electrical plug: wire colors WH-white BK-black BL-blue BN-brown
1 and 7	Supply voltage 24VAC/DC		
2 and 8	Temperature sensor circuit 1	23 and 24	RS485 (+/-)terminal)
3 and 8	Temperature sensor circuit 2	25 and 26	Alarm relay circuit 1 (C, NO) – Suitable for 24VAC/DC
4 and 5	PT5/PT6 circuit 1 & circuit 2 (white wire: 4...20 mA signal)	27 and 28	Alarm relay circuit 2 (C, NO) – Suitable for 24VAC/DC
9	+ 12VDC Voltage input for PT5/PT6 (brown wire)	29 and 30	Digital input circuit1 (DI1) – Dry contact, potential free
Alternative ratiometric third Party Pressure Transmitter:			
4 and 5	Pressure transmitter circuit 1 & circuit 2 (0.5...4.5V signal)	31 and 30	Digital input circuit 2 (DI2) – Dry contact, potential free
11	+ 5VDC voltage input	35 and 36	Battery/Super capacitor connection terminal
10	GND Ground	④	Fuse
		6,12,13, 18,32-34	Not used (Terminals on EXD-SH12)

Note: No hard failure detection if ground wire of transmitter to be interrupted

EXD-SH1/2 Controller with ModBus Communication Capability

Available configuration options

	Selectable Valves		
	FX5-9	EX4-8	CX4-7
Refrigerants	R134a, R407C, R410A, R22, R32*	R22, R23, R32*; R124, R134a, R404A, R407C, R407A, R407F, R507, R744	R744 (CO ₂)
Main function	Superheat control	Superheat or and temperature control	Superheat control
Pressure transmitters	PT5, PT6 or 3 rd party ratio metric	PT5, PT6 or 3 rd party ratio metric	PT5

*) R32 is for systems/regions which it does not consider R32 as potential explosive media (flammable or low flammable) and PED/CE marking is not required.

EXD-SH1/2 IS NOT ATEX APPROVED.

Technical Data: EXD-SH1/2

Supply voltage	24VAC/DC ±10%, 50/60Hz
Power consumption	EXD-SH1: Max. 25VA EXD-SH2: Max. 50VA
Terminals 1 to 12	Suitable for 12 poles molex plug
Terminals 13 to 36	Suitable for removable screw version: wire size 0.14 ... 1.5mm ² Included in controller delivery
Protection class	IP 00
Compliance	EMC, RoHS,
Marking	

Mounting	DIN rail mounted
Temperatures storage operating/ surrounding	-25°C...+60°C 0°C...+60°C
Relative humidity	20...85% non condensing
Accessory (12 poles molex plug with 3 m cable)	Type: EXD-M03 (to be ordered separately)
Housing	Self-extinguishing ABS
Weight	320 g

Input, Output EXD-SH1/2

Description	Specification
Analogue input(s): NTC Temperature sensor Analogue input: PT1000 Temperature sensor	ECN-N... (-45°C ... +50°C sensing range) ECN-Z60 (-80°C ... -40°C sensing range)
Analogue input(s): 4...20 mA pressure transmitters Analogue input(s): 0.5...4.5 V pressure transmitters	PT5 / PT6 Third party ratio metric pressure transmitters (total error: ≤ 1%)
Digital input(s)	Dry contact, potential free
Digital output(s): Alarm relay(s) Contact is closed: During alarm condition Contact is open: During normal operation and supply power OFF	Resistive Load 24 V AC/DC, max. 1 A Inductive Load 24 V AC, max. 0.5 A
Communication	RS485 RTU Modbus, two wires
Stepper motor output	Valves: EX4-8, CX4-7 and FX5-9

EXD-SH1/2 Controller with ModBus Communication Capability

Optional EXD-PM supercap

Supply voltage	24VAC/DC $\pm 10\%$, 50/60Hz
Output voltage	12 VDC
Max. output current	- 1.2 A - 350 mA during charging
Power consumption	12VA
Terminals	Suitable for removable screw version: wire size 0.14 ... 1.5mm ²
Output: to driver/controller	Suitable for one EXD-SH1 Two EXD-PM for one EXD-SH2
Charging time	60 seconds
Max. cable length between EXD-PM and EXD-SH1/2	50 cm AWG18 wire size

Protection class	IP 20
Mounting	DIN rail mounted
Temperatures storage operating/ surrounding	-20 ... +70°C -10 ... +60°C
Housing	Self-extinguishing ABS
Relative humidity	20 ... 85% non condensing
Marking	CE and EAC pending
Weight	125 g

Optional Uninterruptible Power Supply ECP-024

Backup battery type	Lead acid gel rechargeable battery
Number of backup batteries	2, each 12VDC, 0.8Ah
Supply voltage	24VAC $\pm 10\%$, 50-60Hz
Output voltage, UB	18VDC
Number of outputs to drivers	2
Battery recharge time	approximately 2 hours
Marking	CE and EAC pending

Protection class	IP 20
Mounting	DIN rail mounted
Temperatures storage operating/ surrounding	-20 ... +65°C -10 ... +60°C
Housing	Aluminum
Relative humidity	< 90% non condensing
Connection	Screw terminals for wire size 0.5-2.5 mm ²
Accessories: Terminals	K09-U00 Part.No: 804559
Weight	1200 g

Dimensions [mm]

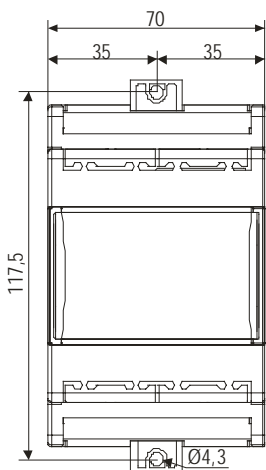

EXD-SH1/2 or EXD-PM

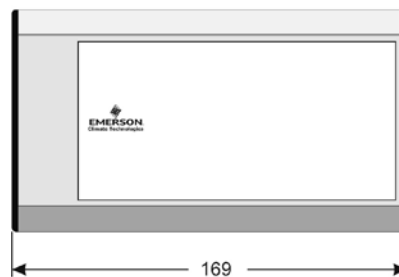
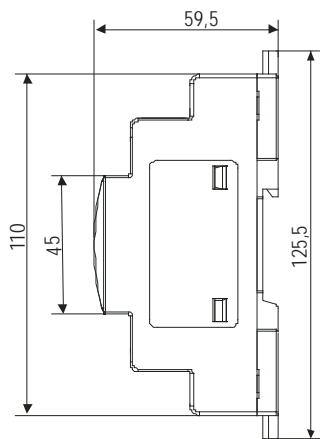

ECP-024

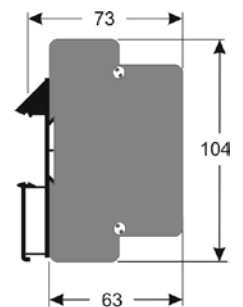

Communication

The use of communication is not necessary/mandatory; however the communication is available for connection to upper level of system controller (third party controller) in order to perform data and commands transfer as well as data logging. EXD-SH1/2 act as slave and third party controller is master. In case of several EXD-SH1/2 connections to master, each driver needs to be addressed for proper communication.

Bus topology

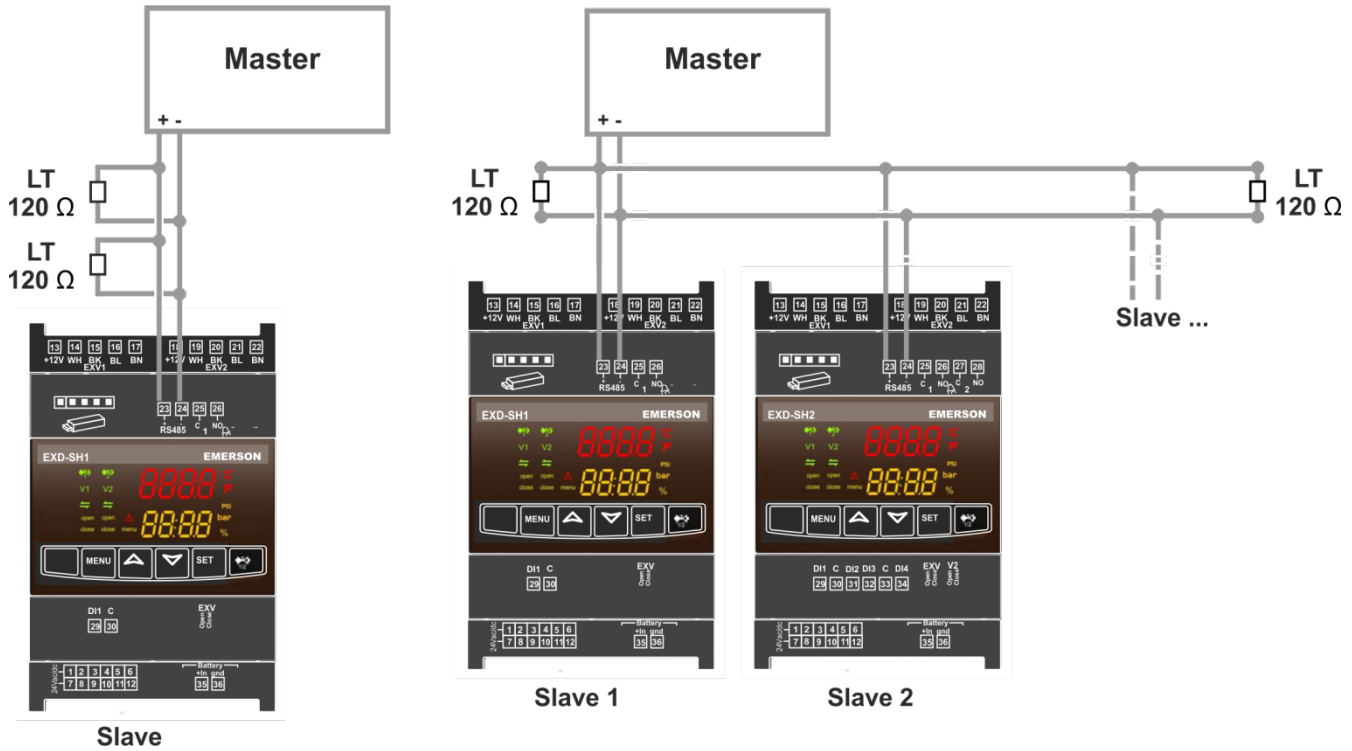

ModBus protocol details

Mode: RTU
 Modbus slave address range: 1 to 127 (parameter **Adr**)
 Baud rate: 9600 bps, 19200 bps (default, parameter **Br**)
 Start bit: 1
 Data bits: 8
 Parity: even (default), no parity (parameter **Par**)
 Stop bits: 1
 Master response timeout: 500ms

Transmission Details

ModBus register address ranges

Read-only data: Starting address: 0x0100 (256)
 Writable data: Starting address: 0x0200 (512)
 Configuration data: Starting address: 0x0300 (768)

Read Data transmission

Available through Modbus Function code 03 (0x03) Read Holding Registers

Request

Function code	1 Byte	0x03
Starting Address	2 Bytes	0x0000 to 0xFFFF
Register count	2 Bytes	1 to 125 (0x7D)

Response

Function code	1 Byte	0x03
Byte count	1 Byte	2 x N*
Holding Registers	N* x 2 Bytes	

*N = Quantity of Input Registers

Error

Error code	1 Byte	0x83
Exception code	1 Byte	01 or 02 or 03

01 = Function code not supported
 02 = Starting Address or register count out of range
 03 = Register count out of range

Write Data transmission (single register)

Available through Modbus Function code 06 (0x06) Write Holding Register

Request

Function code	1 Byte	0x06
Starting Address	2 Bytes	0x0000 to 0xFFFF
Value	2 Bytes	0x0000 to 0xFFFF

Response

Function code	1 Byte	0x06
Starting Address	2 Bytes	0x0000 to 0xFFFF
Value	2 Bytes	0x0000 to 0xFFFF

Error

Error code	1 Byte	0x86
Exception code	1 Byte	01 or 02 or 03

01 = Function code not supported
 02 = Starting Address out of range

Write Data transmission (multiple registers)

Available through Modbus Function code 16 (0x10) Write Holding Registers

Request

Function code	1 Byte	0x10
Start Address	2 Bytes	0x0000 to 0xFFFF
Register count	2 Bytes	0x0001 to 0x0078
Byte count	1 Byte	2 x N
Registers values	2 x N Bytes	Value

N = register count.

Response

Function code	1 Byte	0x10
Starting Address	2 Bytes	0x0000 to 0xFFFF
Register count	2 Bytes	0x0001 to 0x0078

Error

Error code	1 Byte	0x90
Exception code	1 Byte	01 or 02 or 03

01 = Function code not supported
 02 = Register Address invalid
 03 = Register Value out of range

EXD-SH1/2 Controller with ModBus Communication Capability

Read-only variables

Modbus address dec.	Modbus address hex.	Description	Unit	Remarks
256	0x100	Software version		Hexadecimal format 1 hex digit for controller type 1 = SH1, 2 = SH2 1 hex digit for major revision 2 hex digits for minor revision
Circuit 1				
257	0x101	Main function, circuit 1		0 = superheat control 1 = temperature control 2 = reverse temperature control
258	0x102	Valve opening circuit 1	1/100 %	
259	0x103	Digital input circuit 1		0x0000 = No demand 0x0001 = Demand
260	0x104	Digital output circuit 1		0x0001 = alarm relay
261	0x105	P1 suction pressure circuit 1	1/100 barg	
262	0x106	T1 suction temperature circuit 1	1/100 °C	
263	0x107	Sat. Temp circuit 1	1/100 °C	
264	0x108	Pressure 1 sensor failure circuit 1		0 = No failure 1 = Failure
265	0x109	Temp 1 sensor failure circuit 1		0 = No failure 1 = Failure
266	0x10A	Functional Alarm set circuit 1		0x0001 = N/A 0x0002 = Low pressure 0x0004 = High superheat 0x0008 = Low superheat 0x0010 = Freeze 0x0020 = Max. Temp (Temp control) 0x0040 = Min. Temp (Temp control)
267	0x10B	Hardware alarm set		0x0001 = Temp sensor 1 0x0002 = Temp sensor 2 (SH2) 0x0004 = Pressure sensor 1 0x0008 = Pressure sensor 2 (SH2) 0x0010 = Stepper 1 0x0020 = Stepper 2 (SH2) 0x0040 = Modbus timeout (3sec) 0x0080 = Config. inconsistency 1 0x0100 = Config. inconsistency 2 0x0200 = Power Failure
268	0x10C	Application state circuit 1		0 = OFF 1 = Waiting startup (valve reference is pending) 2 = Startup 3 = Control 4 = Closing 5 = Alarm 6 = Manual mode 7 = Power fail 8 = MOP
269	0x10D	Superheat set point circuit 1	1/100 K	
270	0x10E	Superheat circuit 1	1/100 K	

EXD-SH1/2 Controller with ModBus Communication Capability

Read-only variables

Modbus address dec.	Modbus address hex.	Description	Unit	Remarks
Circuit 2				
271	0x10F	Valve opening circuit 2	1/100 %	
272	0x110	Digital input circuit 2		0 = no demand 1 = demand
273	0x111	Digital output circuit 2		0x0001 = alarm relay
274	0x112	P2 suction pressure circuit 2	1/100 bar	
275	0x113	T2 suction temperature circuit 2	1/100 °C	
276	0x114	Sat. Temp circuit 2	1/100 °C	
277	0x115	Pressure 2 sensor failure circuit 2		0 = No failure 1 = Failure
278	0x116	Temp 2 sensor failure circuit 2		0 = No failure 1 = Failure
279	0x117	Functional alarm circuit 2		0x0001 = N/A 0x0002 = Low pressure 0x0004 = High superheat 0x0008 = Low superheat 0x0010 = Freeze
280	0x118	Application state circuit 2		0 = OFF 1 = Waiting startup (valve reference is pending) 2 = Startup 3 = Control 4 = Closing 5 = Alarm 6 = Manual mode 7 = Power fail 8 = MOP
281	0x119	Superheat setpoint circuit 2	1/100 K	
282	0x11A	Superheat circuit 2	1/100 K	

EXD-SH1/2 Controller with ModBus Communication Capability

Writable variables

Modbus address dec.	Modbus address hex.	Display code	Description	Unit	Remarks
512	0x0200		Factory default		1 = do a factory default
513	0x0201		Future use		
514	0x0202		Alarm reset		1 = Resets alarms (only the alarms which are set as manual reset)
515	0x0203	1Ho	Manual mode circuit 1		0 = off, 1 = on
516	0x0204	1HP	Manual valve opening circuit 1	%	only active while manual mode = on
517	0x0205		Alternative to digital input, circuit 1 via Modbus		Demand circuit 1 0 = disabled 1 = enabled
518	0x0206		Pressure circuit 1 via Modbus	1/100 barg	Pressure if 1uP selection is Modbus Range : -0.1 to 150 barg Minimum update rate : 1s Alarm timeout: 3 sec
519	0x207		Digital output circuit 1		To set the relay 1 manually, only active when manual mode circuit 1 = on 0 = off 1 = on
520	0x0208	2Ho	Manual mode circuit 2		0 = off, 1 = on
521	0x0209	2HP	Manual valve opening circuit 2	%	only active while manual mode 2 = on
522	0x020A		Alternative to digital input, circuit 2 via Modbus		Demand circuit 2 0 = disabled 1 = enabled
523	0x020B		Pressure circuit 2 via Modbus	1/100 barg	Pressure if 2uP selection is Modbus Range : -0.1 to 150 barg Minimum update rate : 1s Alarm timeout: 3 sec
524	0x20C		Digital output circuit 2		To set the relay 2 manually, only active when manual mode circuit 2 = on 0 = off 1 = on

References to control circuit 2 are invisible in configuration/write list if disabled

Configuration parameters

Modbus address dec.	Modbus address hex.	Display code	Description	Unit	Default value	Range	Remarks
768	0x300	H5	Password		12	1 - 1999	
769	0x301	Adr	Modbus address		1	1 - 127	
770	0x302	br	Modbus baudrate		0	0 - 1	0 = 9600 baud 1 = 19200 baud
771	0x303	PAr	Modbus parity		0	0 - 1	0 = parity even 1 = no parity
773	0x305	-C2	Circuit 2 Enabled		1	0 - 1	0 = circuit 2 disabled 1 = circuit 2 enabled Only EXD-SH2
774	0x306	-uC	Units conversion		0	0 - 1	0 = °C, K, barg 1 = °F, psig This parameter only affects the display. Internally (as well as for MODBUS communication) the units are always SI-based.
775	0x307		Future use				
776	0x308		Future use				

EXD-SH1/2 Controller with ModBus Communication Capability

Configuration parameters

Modbus address dec.	Modbus address hex.	Display code	Description	Unit	Default value	Range	Remarks
Circuit 1							
777	0x309	1Fct	Function circuit 1		0	0 - 2	Changes only allowed if circuit 1 is in OFF state 0 = superheat control 1 = Temperature control Normal sense 2 = Temperature control Reverse sense
778	0x30A	1u4	Control mode circuit 1		0	0 - 2	0 = standard control 1 = slow control 2 = intermediate control
779	0x30B	1u0	Refrigerant circuit 1		1	0 - 16	Changes only allowed if circuit 1 is in OFF state 0 = R22, 1 = R134a, 2 = R507, 3 = R404A, 4 = R407C, 5 = R410A, 6 = R124, 7 = R744 8 = R407A, 9 = R407F, 10 = R23, 11 = R32 12 = R1234ze, 13 = R448A 14 = R449A, 15 = R450A 16 = R513A
780	0x30C	1uP	Pressure sensor type 1		1	0 - 7	Changes only allowed if circuit 1 is in OFF state 0 = PT5-07x, 1 = PT5/PT6-18x 2 = PT5/PT6-30x 3 = PT5/PT6-50x 4 = PT5-150 5 = Ratio metric(gauge) 6 = Ratio metric(absolute) 7 = Modbus
781	0x30D	1Prr	Ratio metric range 1	1/10 bar	30	3 - 60	If ratiometric is used
782	0x30E	1ut	Valve type 1		0	0 - 11	Changes only allowed if circuit 1 is in OFF state 0 = EX4-6, 1 = EX7, 2 = EX8, 3 = FX5, 4 = FX6, 5 = FX6.5, 6 = FX7, 7 = FX7.5, 8 = FX8, 9 = FX9, 10 = CX4-6, 11 = CX7
783	0x30F	1uF	Valve scaling 1	%	100	50 - 100	
784	0x310	1uu	Start opening valve1	%	10	5 - 100	
785	0x311	1u9	Start opening duration valve 1	s	5	1 - 120	
786	0x312	1uL	Low superheat alarm mode circuit 1		1	0 - 2	0 = disabled 1 = enabled auto-reset 2 = enabled manual reset
787	0x313	1u5	Superheat setpoint circuit 1	1/10 K	6	0.5 - 30	Range = 3 – 30K with 1uL = 1,2
788	0x314	1u2	MOP mode circuit 1		1	0 - 1	0 = disabled 1 = enabled

Configuration parameters

Modbus address dec.	Modbus address hex.	Display code	Description	Unit	Default value	Range	Remarks
789	0x315	1u3	MOP sat. temp. limit circuit 1	1/10 °C			
790	0x316	1P9	Low pressure alarm mode circuit 1		0	0 - 2	0 = disabled 1 = enabled auto-reset 2 = enabled manual reset
791	0x317	1PA	Low pressure alarm cut-out circuit 1	1/10 bar	0	-0.8 - 17.7	
792	0x318	1Pb	Low pressure alarm delay circuit 1	s	5	5 - 199	
793	0x319	1Pd	Low pressure alarm cut-in circuit 1	1/10 bar	0.3	-0.5 - 18	
794	0x31A	1P4	Freeze alarm mode circuit 1		0	0 - 2	0 = disabled 1 = enabled auto-reset 2 = enabled manual reset
795	0x31B	1P2	Freeze alarm cut-out circuit 1	1/10 °C	0	-5 - 5	
796	0x31C	1P5	Freeze alarm delay circuit 1	s	30	5 - 199	
797	0x31D	1uH	High superheat alarm mode circuit 1		0	0 - 1	0 = disabled 1 = enabled auto-reset
798	0x31E	1uA	High superheat alarm setpoint circuit 1	1/10 K	30	16 - 40	
799	0x31F	1ud	High superheat alarm delay circuit 1	min	3	1-15	
800	0x320	1tSt	Temperature set point	1/10 °C	4	-50 - 50	
801	0x321	1tbd	Temperature band	1/10 K	2	1 - 10	
802	0x322	1tAF	Temperature alarm enable		0	0 - 1	0 = disabled 1 = enabled
803	0x323	1tAL	Min. temperature alarm set-point	1/10 °C	0	-50 - 50	
804	0x324	1tdL	Min. temperature alarm delay	min	3	1 - 10	
805	0x325	1tAH	Max. temperature alarm set-point	1/10 °C	15	-50 - 50	
806	0x326	1tdH	Max. temperature alarm delay	min	3	1 - 10	
807	0x327		Future use				
808	0x328		Future use				
809	0x329	1tt-	Temperature sensor type		0	0 - 1	0 = ECN-Nxx 1 = ECN-Z60
Circuit 2							
810	0x32A	2u4	Control mode circuit 2		0	0 - 2	0 = standard control 1 = slow control 2 = intermediate control
811	0x32B	2u0	Refrigerant circuit 2		1	0 - 16	Changes only allowed if circuit 2 is in OFF state 0 = R22, 1 = R134a, 2 = R507, 3 = R404A, 4 = R407C, 5 = R410A, 6 = R124, 7 = R744 8 = R407A, 9 = R407F, 10 = R23, 11 = R32 12 = R1234ze, 13 = R448A 14 = R449A, 15 = R450A 16 = R513A

EXD-SH1/2 Controller with ModBus Communication Capability

Modbus address dec.	Modbus address hex.	Display code	Description	Unit	Default value	Range	Remarks
812	0x32C	2uP	Pressure sensor type circuit 2		1	0 - 7	Changes only allowed if circuit 2 is in OFF state 0 = PT5-07x 1 = PT5/PT6-18x 2 = PT5/PT6-30x 3 = PT5/PT6-50x 4 = PT5-150 5 = Ratio metric (gauge) 6 = Ratio metric (absolute) 7 = Modbus
813	0x32D	2Prr	Ratio metric range circuit 2	1/10 bar	30	3 - 60	If ratio metric is used
814	0x32E	2ut	Valve type circuit 2		0	0 - 11	Changes only allowed if circuit 2 is in OFF state 0 = EX4-6, 1 = EX7, 2 = EX8, 3 = FX5, 4 = FX6, 5 = FX6.5 6 = FX7, 7 = FX7.5, 8 = FX8, 9 = FX9, 10 = CX4-6, 11 = CX7
815	0x32F	2uF	Valve scaling circuit 2	%	100	50 - 100	
816	0x330	2uu	Start opening valve circuit 2	%	10	5 - 100	
817	0x331	2u9	Start opening duration valve circuit 2	s	5	1 - 120	
818	0x332	2uL	Low superheat alarm mode circuit 2		1	0 - 2	0 = disabled 1 = enabled auto-reset 2 = enabled manual reset
819	0x333	2u5	Superheat setpoint circuit 2	1/10 K	6	0.5 - 30	Range = 3 – 30K with 1uL = 1,2
820	0x334	2u2	MOP mode circuit 2		1	0 - 1	0 = disabled 1 = enabled
821	0x335	2u3	MOP sat. temp. limit circuit 2	1/10 °C			see MOP table
822	0x336	2P9	Low pressure alarm mode circuit 2		0	0 - 2	0 = disabled 1 = enabled auto-reset 2 = enabled manual reset
823	0x337	2PA	Low pressure alarm cut-out circuit 2	1/10 bar	0	-0.8 - 17.7	
824	0x338	2Pb	Low pressure alarm delay circuit 2	s	5	5 - 199	
825	0x339	2Pd	Low pressure alarm cut-in circuit 2	1/10 bar	0.3	-0.5 - 18	
826	0x33A	2P4	Freeze alarm mode circuit 2		0	0 - 2	0 = disabled 1 = enabled auto-reset 2 = enabled manual reset
827	0x33B	2P2	Freeze alarm cut-out circuit 2	1/10 °C	0	-5 - 5	
828	0x33C	2P5	Freeze alarm delay circuit 2	s	30	5 - 199	
829	0x33D	2uH	High superheat alarm mode circuit 2		0	0 - 1	0 = disabled 1 = enabled auto-reset
830	0x33E	2uA	High superheat alarm setpoint circuit 2	1/10 K	30	16 - 40	
831	0x33F	2ud	High superheat alarm delay circuit 2	min	3	1-15	

EXD-SH12_TB_EN_1512_R05.docx

Emerson Climate Technologies GmbH shall not be liable for errors in the stated capacities, dimensions, etc., as well as typographic errors. Products, specifications, designs and technical data contained in this document are subject to modification by us without prior notice. Illustrations are not binding.
The Emerson Climate Technologies logo is a trademark and service mark of Emerson Electric Co. Emerson Climate Technologies Inc. is a subsidiary of Emerson Electric Co.

EMERSON. CONSIDER IT SOLVED.