

MAXIMUM SENSING LOCATIONS PER THERMOSTAT								
	Thermostat Model Number	Indoor Sensing Locations				Remote Sensor Priority Assignment (LO/AVG/HI)	Allows Outdoor Remote Sensor	Sensor Set Up
		Total (Max.)	Thermostat Onboard Sensor	Remote Sensor				
Single Stage	1F90-371	1	OFF*	With	1*	-	-	Clip Jumper W922 and Enable Sensor in Menu
	1F96-344	1	OFF*	With	1*	-	-	Clip Jumper W922 and Enable Sensor in Menu
	1F97-1277 (Blue)	2	ON or OFF	+	1	Yes	Yes***	Enable Sensor in Menu
	1F97-371	1	OFF*	With	1*	-	-	Clip Jumper W922 and Enable Sensor in Menu
	1F97-391	1	OFF*	With	1*	-	-	Clip Jumper W922 and Enable Sensor in Menu
Staging	1F93-380	4	ON or OFF	+	Up to 3	Yes**	Yes	Enable Sensor in Menu
	1F94-371	4	ON or OFF	+	Up to 3	Yes**	Yes	Enable Sensor in Menu
	1F95-1277 (Blue)	2	ON or OFF	+	1	Yes	Yes***	Enable Sensor in Menu
	1F95-371	4	ON or OFF	+	Up to 3	Yes**	Yes	Enable Sensor in Menu
	1F95-377	4	ON or OFF	+	Up to 3	Yes**	Yes	Enable Sensor in Menu
	1F95-391	4	ON or OFF	+	Up to 3	Yes**	Yes	Enable Sensor in Menu

*Using a Remote Sensor On This Model Requires the Onboard Thermostat Sensor To Be Off.

**Allows A Sensor Priority of LO, AVG., or HI To Be Assigned To The Onboard Thermostat Sensor In Addition Remote Sensors.

***Accepts One Remote Sensor, Indoor or Outdoor.

REMOTE SENSOR CALCULATED PRIORITY AVERAGE

Consult Maximum Sensing Locations Per Thermostat chart on page 6 to determine how many sensors a thermostat will accept.

Tables 1-3 show how priority (LO, AVG, HI) effects the room temperature calculation. The example below table three shows the calculation of each remote sensor and how it uses them to arrive at room temperature average.

Table 1: Remote Sensor A configured as a LO priority sensor

Remote Sensor	Sensor Priority	Priority Multiplier	Room Temperature	Averaging Calculation
SA	LO	1	70°F (Sensor Temp.)	1 x 70 = 70 (Priority Multiplier x Room Temp.)

Table 2: Remote Sensor B configured as a AVG priority sensor

Remote Sensor	Sensor Priority	Priority Multiplier	Room Temperature	Averaging Calculation
SB	AVERAGE	2	75°F (Sensor Temp.)	2 x 75 = 150 (Priority Multiplier x Room Temp.)

Table 3: Remote Sensor C configured as a HI priority sensor

Remote Sensor	Sensor Priority	Priority Multiplier	Room Temperature	Averaging Calculation
SC	HI	4	80°F (Sensor Temp.)	4 x 80 = 320 (Priority Multiplier x Room Temp.)

The example below lists three sensors each with a different priority and room temperature. All three sensors are combined in the calculation to display the average temperature. The priority multiplier shown in the tables above causes a sensor with low priority to carry less weight in the calculated average. A sensor with a HI priority setting contributes more to the calculated average. Assume that the building in which the thermostat is located has three indoor remote sensors (SA, SB, SC) that have different room temperatures (70, 75, 80). The calculated average will be displayed as the room temperature shown in the example below.

Example: Remote Sensors A, B, and C configured as a LO, AVG, and HI priority sensors

Remote Sensor	Sensor Priority	Priority Multiplier	Room Temperature	Averaging Calculation
SA	LO	1	70°F (Sensor Temp.)	1 x 70 = 70 (Priority Multiplier x Room Temp.)
SB	AVERAGE	2	75°F (Sensor Temp.)	2 x 75 = 150 (Priority Multiplier x Room Temp.)
SC	HI	4	80°F (Sensor Temp.)	4 x 80 = 320 (Priority Multiplier x Room Temp.)
				Avg. Calc. (540)/Sum Priority Mult. (7)
				540/7 = 77°F (Calculated Displayed Temp.)

Troubleshooting Chart

To function correctly and read temperature accurately, the thermostat must have constant 24-volt power. If the thermostat temperature is steadily dropping, reading low, or reads 08° when a remote sensor is installed, it can be traced to one of the three following conditions.

Condition	Test	Comments
1. Loss of 24-volt power.	On models with batteries, remove the batteries and re-install thermostat. If the display is blank, check heating and cooling system to determine why 24-volt power is absent.	For the sensor to read correctly, the 24-volt system power must be present. Some systems may require an isolation relay* to provide constant power to the thermostat. Limit or safety devices in the equipment can also cause a power interruption.
2. A broken wire on S1, S2 and S3 or (+, SA, -) from the thermostat to the remote.	Disconnect sensor wires at thermostat. Attach a short piece (2') of three-wire shielded cable to S1, S2 and S3 or (+, SA, -) on the subbase. Bring the remote sensor to the thermostat location and attach S1, S2 and S3 or (+, S, -) respectively. Reattach thermostat. If the temperature begins to climb (slowly), it is reading correctly. If it reads correctly with the 2' length but improperly when attached to the wire run, it indicates a fault in the wire run.	Repair or replace the 3 wire shielded cable. Be sure the remote wire run is not parallel to line voltage wires that carry heavy inductive loads, or across fluorescent light ballasts that may cause an inductance to be transmitted to the thermostat.
3. A shorted or damaged remote sensor.	Because it is an electronic sensor, there are no Ohm values to test. If correct conditions as listed in 1 & 2 above and the temperature stays at or near 08°, it indicates a shorted or damaged remote sensor.	Replace remote sensor.

Note: Digital thermostats and remote sensors acclimate very slowly to temperature change. It may take an hour or more for the temperature to acclimate to the room temperature from a low temperature reading as outlined above. To expedite the room temperature display use the reset instructions listed in the installation instructions for the thermostat model you are working with. When reset, the thermostat will default to a room temperature of 70° and begin sensing room temperature. Be sure to reconfigure the installer menu for a remote sensor because the reset function may cancel remote sensing.

* Isolation Relay Wiring

Note: The diagram below shows how to attach an isolation relay to the “W” or “Y” circuit to provide constant power on power stealing thermostats. This will allow the thermostat to operate properly with a remote sensor.

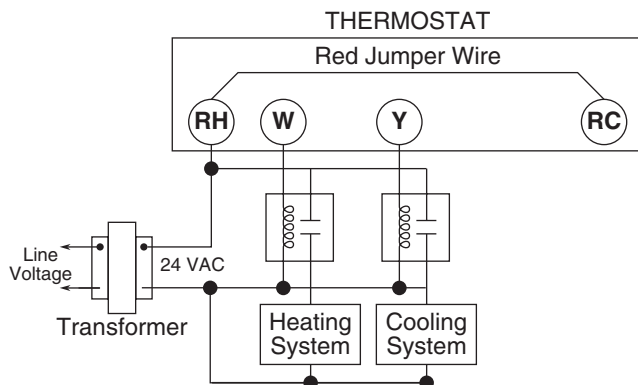
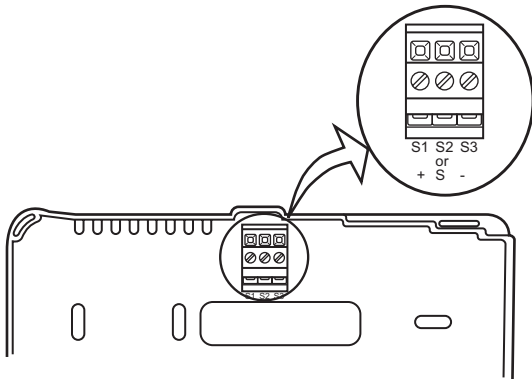

Figure 1. Wiring for single transformer systems

Figure 1 shows a single transformer heating/cooling system, with isolation relays installed in the heating (W) and cooling (Y) circuits. To simplify the diagram, limit and safety switches are not shown here, although they will be found either in the low or high voltage circuit. Limit and safety switches **must be retained**. Refer to the equipment manufacturer’s system wiring diagram for the location of limit and safety switches.

⚠ WARNING

DO NOT REMOVE OR WIRE AROUND LIMIT AND SAFETY SWITCHES WHEN INSTALLING ISOLATION RELAYS.



Thermostat Subbase

Note: When using shielded cable, connect shield of 18 or 20 gauge 3 connector cable to - or S3 on thermostat subbase.

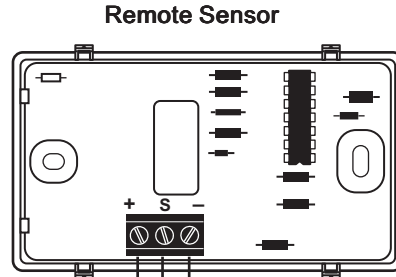

Remote Sensor

To + or S1
To S or S2
To - or S3

Single Stage Thermostat Remote Sensor Wiring (F145-1328)

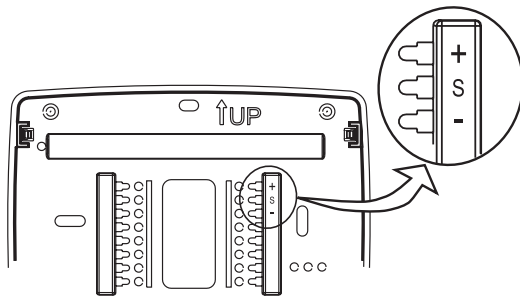

Thermostat Subbase

Note: When using shielded cable, connect shield of 18 or 20 gauge 3 connector cable to - or S3 on thermostat subbase.

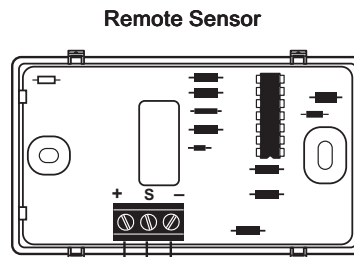

Remote Sensor

To + or S1
To S or S2
To - or S3

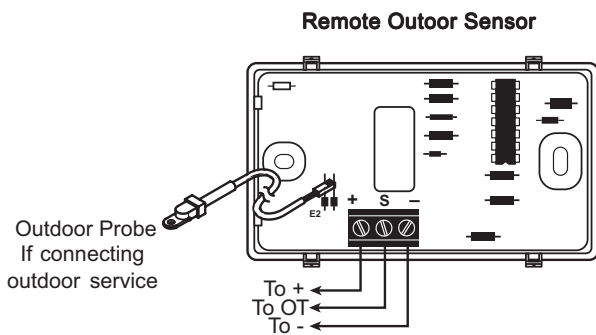

Remote Outdoor Sensor

Outdoor Probe
If connecting
outdoor service

To +
To OT
To -

Staging Multi-Stage or Heat Pump Touchscreen Thermostat (1F95-1277) Indoor/Outdoor Remote Sensor Wiring (F145-1328/F145-1378)

TECHNICAL HELP

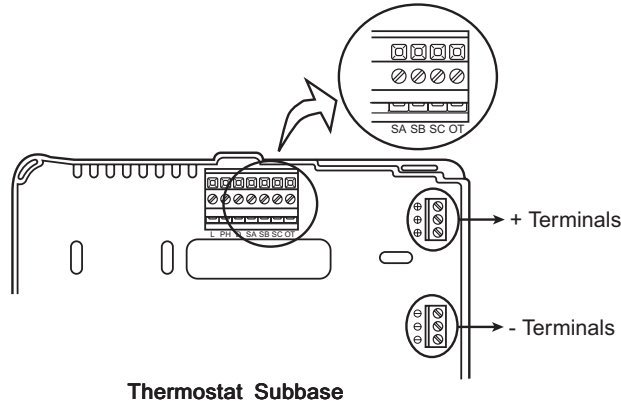

Note: When using shielded cable, connect shield of 18 or 20 gauge 3 connector cable to - or S3 on thermostat subbase.

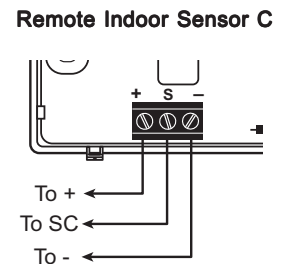
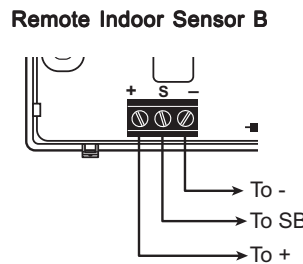
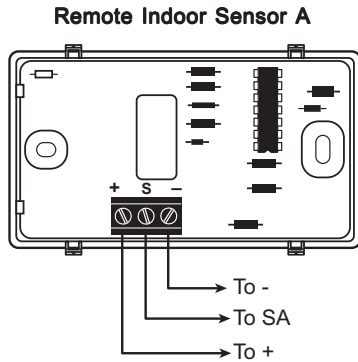
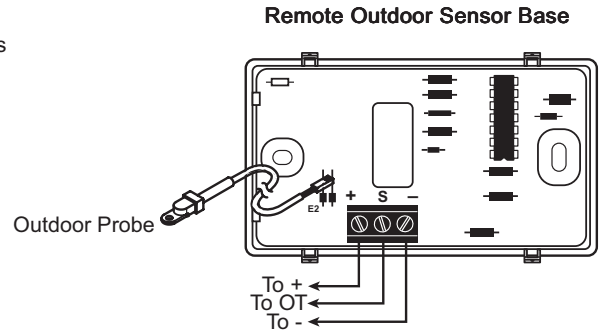

Staging Thermostat Multi-Stage or Heat Pump Indoor/Outdoor Remote Sensor Wiring (F145-1328/F145-1378)

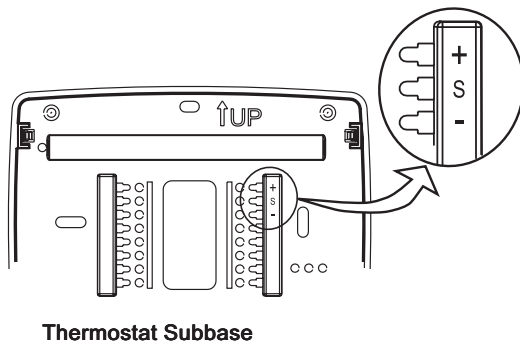

Note: When using shielded cable, connect shield of 18 or 20 gauge 3 connector cable to - or S3 on thermostat subbase.

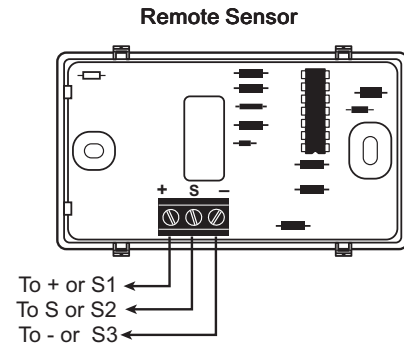
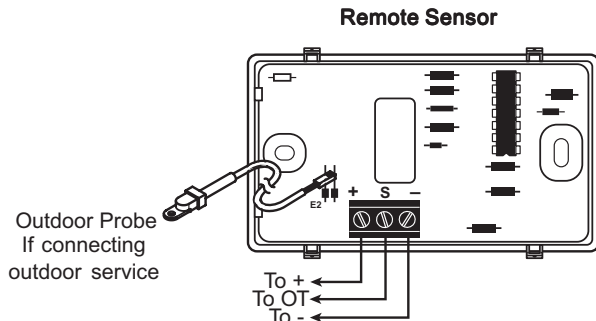

Single Stage (1F97-1277) Touchscreen Thermostat Indoor/Outdoor Remote Sensor Wiring (F145-1328/F145-1378)